

CSN TECHNICAL BULLETIN

No. 10

Bioretention Illustrated:

A Visual Guide for Constructing, Inspecting, Maintaining and Verifying the Bioretention Practice

Version 2.0
October 20, 2013



Prepared by:

Ted Scott
Stormwater Maintenance & Consulting
Cecilia Lane & Tom Schueler
Chesapeake Stormwater Network



www.swmaintenance.com | www.mdswm.com

Table of Contents

	Page
Section 1: Basics of Bioretention: What it Does and How it Works	5
Section 2: The Construction Sequence for Bioretention	13
Section 3: The Visual Indicators Framework	20
Section 4: Visual Indicators for Bioretention	23
Section 5: Inspections and Maintenance	27
5.1 The Establishment Phase and Final Inspection	27
5.2 The Bioretention Maintenance Regime	28
5.3 Regular Maintenance Checkups and Repair	30
5.4 Local Regulatory Inspections	32
5.5 BMP Performance Verification	33
Section 6: Forensic BMP Investigations	36
References Cited	42
Appendix A: Visual Indicator Profile Sheets for Bioretention	43
Appendix B: Visual Indicators for Other LID Practices	62
B.1 Grass Channels	62
B.2 Filters Strips and Sheet Flow to Buffers	71
B.3 Permeable Pavement	80
B.4 Infiltration Practices	88

Introduction

The LID Maintenance Challenge

In recent surveys conducted by CSN, local stormwater managers have expressed major concerns about the long term maintenance of low impact development (LID) practices, and the lack of inspection protocols for small-scale practices. Clearly, most communities will have many, many more small practices to report, track, inspect and verify.

The same communities will soon get more prescriptive MS4 permits that will require ongoing maintenance inspection for their entire best management practices (BMPs) inventory in a single permit cycle. In addition, localities may soon have to improve their BMP reporting, tracking and reporting to maintain pollutant reduction credits for the Bay pollution diet or total maximum daily load (TMDL)...And given the state of most local stormwater budgets, they are not likely to get additional staff resources to get the job done.

A New Model for LID Maintenance

The transition to the new LID paradigm requires a new model for efficiently inspecting and maintaining practices over their entire life cycle. This technical bulletin outlines a new visual indicators approach for doing so that is based on the following principles:

- Use simple visual indicators to conduct rapid inspections of individual practices in less than a half hour
- Apply a "triage approach" to focus time and staff resources on fixing the practices in the worst condition
- Use measurable and numeric maintenance "triggers" to develop a punch-list of maintenance tasks and let the owner know how to fix minor, moderate and severe maintenance problems
- Take a proactive approach to maintenance rather than a reactive one so that the maintainer understands the function and design objective for the practice, can immediately fix minor problems and prevent major problems, schedule a follow up visit to address moderate problems, and report severe problems to the owner or local stormwater maintenance authority.
- Confine the efforts of engineers and project estimators to careful construction inspections to ensure they are installed properly and more in-depth "forensic" investigation of failing or non-functional practices and shift inspection responsibilities to inspectors, landscape contractors, and others who may not be trained engineers but could learn to do LID inspection

- In doing all of the above, maximize use of advanced communication, mapping, GPS and data management technology to streamline and integrate maintenance records

Appendix A presents profile sheets that show how each visual indicator is used during bioretention inspection. **Appendix B** provides a list of visual indicators for four other categories of LID practices, as well as numeric maintenance triggers.

Other CSN Initiatives

CSN is working with several partners to craft products and tools to make LID maintenance easier and more cost-effective. A more simplified set of visual indicators are being developed to assess homeowner practices such as on-lot rain gardens, downspout disconnections and rainwater harvesting. CSN also expects to complete Technical Bulletin 11 which will focus on how to build more effective local LID maintenance programs. Finally, CSN aims to develop a tablet or smart phone app to rapidly enter inspection data in the field and develop maintenance punch lists.

Acknowledgements

CSN would like to acknowledge the help of the following people: Ted Scott and William Kopajtic at Stormwater Maintenance & Consulting, Laurel Woodworth, Dave Hirshman, Sadie Drescher and Bryan Seipp at the Center for Watershed Protection, Inc., without whom the production of this technical bulletin would not have been possible.

Support for this technical memo was provided for by the Keith Campbell Foundation and the National Fish and Wildlife Foundation under the Chesapeake Bay Stormwater Training Partnership grant.

CSN would like to thank the following people and organizations for submitting photos for inclusion in this technical bulletin: Ted Scott, Dave Hirshman, Bryan Seipp, Tim Schueler, and the NCSU Stormwater Engineering Group.

Finally, CSN would like to acknowledge the contribution of our reviewers for their careful review of this document: Steve Hubble, Stafford County, VA, Steve Curtis, Luck Stone Corporation, Richard Klein, Community and Environmental Defense Services, Mary Travaglini, Montgomery County DEP, Martin Johnson, Thomas Jefferson Soil & Water Conservation District, Prince William County, VA.

Section 1

Basics of Bioretention: What it Does and How it Works

Bioretention is a stormwater management practice that can achieve both water quantity and water quality goals through runoff reduction and pollutant removal. Pollutant removal is accomplished via processes such as settling, filtering, adsorption, and biological uptake.

Bioretention facilities are known by many different names but they all operate in the same basic way. Table 1 shows some of the different varieties of bioretention facilities.

Table 1. Bioretention Pseudonyms

	
<p><i>Bioretention</i></p>	<p><i>Water Quality Swale</i></p>
	
<p><i>Urban Bioretention</i></p>	<p><i>Residential Rain Garden</i></p>

Regardless of the form the bioretention may take, there are several basic design components that are present to ensure the practice's ability to reduce runoff and remove pollutants. These may include: a ponding area, filter bed (or soil media), stone layer (with or without underdrain), an inlet, overflow device or outlet, and vegetative cover (Figure 1).



Figure 1. Bioretention Schematic (WVDEP)

The way a bioretention facility works is that stormwater flows into it and temporarily ponds on the surface in the **ponding area**. Water then slowly filters through the **filter bed** (or media layer) where it may be collected by the **underdrain** (a perforated pipe beneath the filter bed) and conveyed to the storm sewer system. Not all bioretention practices are designed to have an underdrain, in areas of “good” soils (soils that meet a specific infiltration capacity) a practice can be designed to allow the water to infiltrate into the underlying soils.

Vegetation is a very important component of a bioretention system. As stormwater makes its way through the practice, it is taken up and utilized by the vegetation along with the corresponding nutrients. Figure 2 demonstrates how runoff makes its way through the bioretention area.

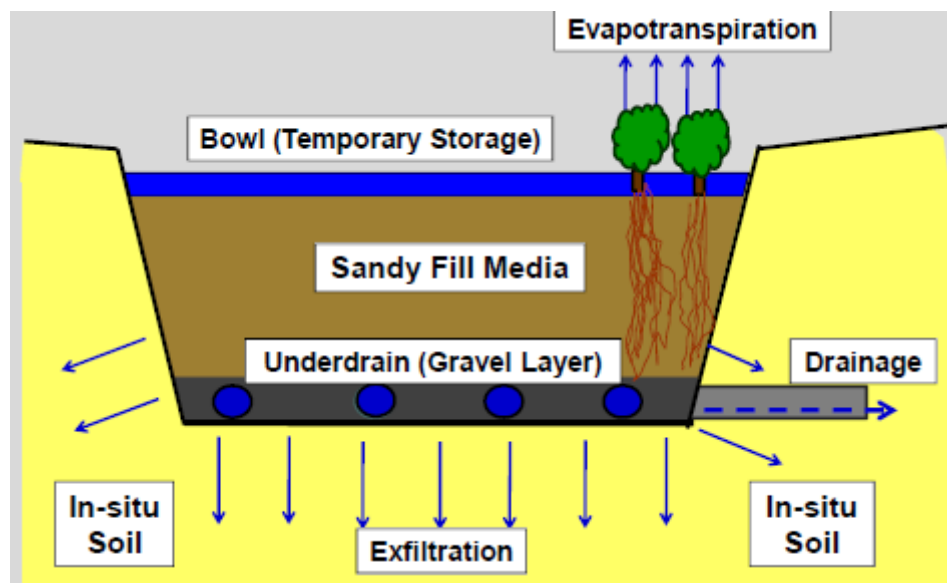

Figure 2. Bioretention Processes (Photo credit: NCSU Stormwater Engineering Group)

Runoff Reduction and Pollutant Removal

Runoff reduction is defined as the total volume of water reduced through canopy interception, soil infiltration, evaporation, rainfall harvesting, engineered infiltration, extended filtration or evapotranspiration. The runoff reduction associated with a bioretention practice ranges anywhere from 40-80% (CWP and CSN, 2008).

Pollutant removal is accomplished via processes such as settling, filtering, adsorption, biological uptake and denitrification. The range of pollutant removal efficiencies for Total Nitrogen (TN), Total Phosphorus (TP) and Total Suspended Solids (TSS) can be seen in Table 2.

Pollutant	% Removal
Total Nitrogen	56-69%
Total Phosphorus	66-80%
Total Suspended Solids	71-86%

The pollutant removal rate of a particular bioretention area can be increased or decreased based on the design components and what pollutant(s) is being targeted for reduction.

Design variations





A bioretention area can vary in how it is designed. Some design variations include using an underdrain in the stone layer to slowly dewater the area, sending remaining runoff back to the storm sewer system, or creating a sump at the bottom of the area in the stone layer where water will infiltrate in to the surrounding soils within 48 hours.

In addition, it is also possible to design the bioretention area so as to meet specific pollutant removal needs. For example, by creating a sump in the bottom of the area, one can achieve enhanced nitrogen removal. These different design variations are illustrated in Table 3.

Table 3. Bioretention Design Variations

<p><i>Standard design</i></p>	<p><i>Infiltration design</i></p>
<p><i>Infiltration sump</i></p>	<p><i>Internal water storage layer (Photo credit: NCSU Stormwater Engineering Group)</i></p>

Runoff enters the bioretention area through the **inlet**. Inlets can vary considerably in the way they are designed to function. Table 4 demonstrates the different types of inlets that are often used with bioretention.





Table 4. Bioretention Inlets	
	
<p><i>Curb cut – flow enter through defined place in curb</i></p>	<p><i>Curb cut</i></p>
	
<p><i>Gravel diaphragm – flow enters as sheetflow and is evenly distributed across length of practice</i></p>	<p><i>Grass filter strip: accepts sheet flow from the parking lot</i></p>

Water leaves the bioretention area through several different means. It can evaporate from the ponding area, be taken-up and utilized or evapo-transpired by the vegetation or infiltrated into the surrounding soils. In addition, most bioretention areas are designed to have a designated **outlet** structure of some kind. Outlet structures can take many different forms and oftentimes depend on the design of the facility. One type of outlet or overflow structure that is often used is an inlet structure that is placed at the maximum design ponding depth so as to allow for bypass of larger stormwater volumes out of the facility. Another is a riser structure that accepts water that exceeds the maximum ponding depth and conveys it to the underground storm drain pipes.

Underdrains are another way that runoff can leave the bioretention. Underdrains either convey water to the existing storm drain or daylight into an above ground swale, woodland, or stream. It is important to know where the underdrains connect to, so you can inspect the outlet. They commonly have clean-out and observation well pipes that surface at pipe intersections. Underdrains are used in environments where the soil conditions make it difficult to infiltrate water into the surrounding area. Underdrains are also useful in situations where the runoff entering the practice is contaminated from

the contributing drainage area (called Hotspots) and so cannot be infiltrated into the surrounding soils due to potential groundwater contamination.

Table 5 shows several different types of outlet structures commonly used for bioretention.

Table 5. Bioretention Outlet Structures	
	
<p><i>Inlet structure: yard inlet placed at the maximum ponding depth to allow for bypass of larger storms</i></p>	<p><i>Inlet Structure as Overflow Device</i></p>
	
<p><i>Observation well or clean out: to inspect drainage in the filter media or the condition of the underdrain</i></p>	<p><i>Underdrain outlet: where the water collected by the underdrain is discharged</i></p>

Pretreatment is necessary to trap sediment and debris before it reaches and clogs the filter bed. There are several different types of pretreatment measures that are used to protect bioretention. Examples can be found in Table 6.

Table 6. Examples of Different Pretreatment Measures Used in Bioretention

	
<p><i>Sediment forebay</i></p>	<p><i>Grass channel</i></p>
	
<p><i>Level spreader</i></p>	<p><i>Gravel Diaphragm</i></p>

Vegetation is an essential component of any bioretention area. As was noted earlier, vegetation is responsible for a significant portion of the pollutant removal and runoff reduction of this stormwater practice. The landscape regime of a bioretention area is often determined by the amount of maintenance it will receive. Often, this is a function of the visibility of the practice.





If the practice will be infrequently maintained, then hardy plant materials should be specified at the various planting zones in the facility. If an owner will have the bioretention area maintained as part of the regular maintenance activities (e.g., grass cutting, weeding, etc) then perhaps a more perennial garden is suitable.

One of the most costly aspects of bioretention maintenance is the cost of supplementing or replacing mulch, if it is specified. Accordingly, careful selection of a diverse plant palette that includes herbaceous material such as ground covers in lieu of widely spaced woody species can result in a reduction in maintenance costs.

Another important factor to consider in designing the landscaping regime of the bioretention is the dynamic nature of vegetation. Typically designers specify material for the immediate conditions. However the systems evolve as the vegetation grows. For example, as trees and shrubs mature, the system might be transformed from a sunny

bioretention to having more shade under trees. Oftentimes, it is beneficial to conduct a plant evaluation specified time increments (i.e., 3 year, 6 year, 9 year and so on) to evaluate the suitability of the plant regime and the appropriateness of the plant material (Gillette, 2013).

Table 7 demonstrates four different typical landscaping regimes for bioretention.

Table 7. Typical Landscaping Regimes for Bioretention	
	
<i>Perennial Garden</i>	<i>Perennial- Shrub</i>
	
<i>Tree-shrub-mulch</i>	<i>Turf-tree</i>

Now that we understand the basics behind how bioretention works, we need to learn basic visual indicators to quickly identify and diagnose maintenance problems that prevent it from functioning properly. The rest of this technical bulletin outlines methods for visually inspecting bioretention through all stages of its life cycle

Section 2

Installing it Right the First Time

The Construction Sequence for Bioretention

Construction inspection is an important step to take to ensure that the project is built to its design specifications, and any changes that are made in the field are acceptable.

The construction inspection is performed in order to meet requirements for the local stormwater management review authority, and is typically conducted by an engineer or trained stormwater professional at critical points in the construction process. (Figure 3).

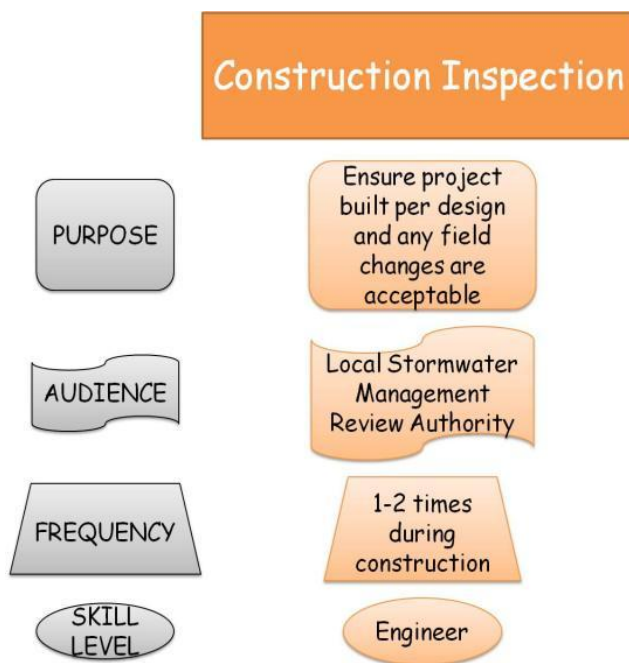

Figure 3. The Construction Inspection Process

Construction Sequence

Table 8 outlines a typical construction sequence for a bioretention area (WV DEP, 2012).

<p>Table 8. A Typical Construction Sequence for a Bioretention Facility</p>	
<p>Step 1. Construction of the bioretention area may only begin after the entire Contributing Drainage Area (CDA) has been stabilized with vegetation.</p> <p>It may be necessary to block certain curb or other inlets while the bioretention area is being constructed. The proposed site should be checked for underground utilities prior to any excavation.</p>	
<p>Step 2. The designer and the installer should have a preconstruction meeting, checking the boundaries of the CDA and the actual inlet elevations to ensure they conform to original design. Since other contractors may be responsible for constructing portions of the site, it is quite common to find subtle differences in site grading, drainage and paving elevations that can produce hydraulically important differences for the proposed bioretention area. The designer should clearly communicate, in writing, any project changes determined during the preconstruction meeting to the installer and the plan review/inspection authority.</p>	
<p>Step 3. Temporary erosion and sediment controls are needed during construction to divert stormwater and sediments away from the bioretention area until it is completed.</p> <p>Special protection measures such as erosion control fabrics may be needed to protect vulnerable side slopes from erosion during the construction process.</p>	

Step 4.

Any pre-treatment cells should be excavated first to trap sediments.



Step 5.

Excavators or backhoes should work from the sides to excavate the bioretention area to its appropriate design depth and dimensions. Excavating equipment should have scoops with adequate reach so they do not have to sit inside the footprint of the bioretention area.

Contractors should use a cell construction approach in larger bioretention basins, whereby the basin is split into 500 to 1,000 sq. ft. temporary cells with a 10-15 foot earth bridge in between, so that cells can be excavated from the side.



Step 6.

It may be necessary to rip (loosen) the bottom soils to a depth of 6 to 12 inches to promote greater infiltration.

(Photo credit: NCSU Stormwater Engineering Group)



Step 7.

If using a filter fabric on the sides, place the fabric with a 6-inch overlap where the ends meet. If an underdrain stone storage layer will be used, place the specified depth of No.57 stone on the bottom, install the perforated underdrain pipe, and place No.57 stone to 3 inches above the underdrain pipe.

On top of the No.57 stone, add 2 inches of choker stone (No.8 or No.89 stone) as specified and then construction sand to the specified depth (often 2 to 4 inches) as a filter between the underdrain and the soil media layer. If no stone storage layer is used, start with 6 inches of No.57 stone on the bottom, and proceed with the layering as described above.



Step 8.

Deliver the soil media from an approved vendor, and store it on an adjacent impervious area or plastic sheeting. Apply the media in 12-inch lifts until the desired top elevation of the bioretention area is achieved. If heavy machinery is used, make sure the machinery works from the edges to avoid compacting any soils or side slopes. Filter media should be hydraulically compacted to avoid future settling. This process involves flooding the soil media after the initial installation to facilitate settling under natural operation conditions. Wait a few days to check for settlement, and add additional media, as needed, to achieve the design elevation. Plantings and mulch will raise the elevation, so where necessary adjust the design elevation to compensate for the soil volume of new plants.



Step 9.

Prepare planting holes for any trees and shrubs, install the vegetation, and water accordingly. Install any temporary irrigation.



Step 10.

Place the surface cover (double shredded mulch, river stone or turf), depending on the design. If coir or jute matting will be used in lieu of mulch, the matting will need to be installed prior to planting (**Step 9**), and holes or slits will have to be cut in the matting to install the plants. Side slopes should be graded to a preferred maximum slope of 3:1 and capped with at least three inches of topsoil and appropriate mulch or matting.



Step 11.

Install the remaining plant materials as shown in the landscaping plan, and water them during weeks of no rain for the first two months.



Step 12.

If curb cuts or inlets are blocked during bioretention installation, unblock these after the drainage area and side slopes have good vegetative cover. It is recommended that unblocking curb cuts and inlets take place after two to three storm events if the drainage area includes newly installed asphalt, since new asphalt tends to produce a lot of fines and grit during the first several storms.



Step 13

Conduct the final inspection, then log the GPS coordinates for each bioretention facility and submit them for entry into the local maintenance tracking database.



Critical Inspection Points in the Sequence

There are several points during the construction process where inspection is necessary to ensure proper installation that if are not handle properly will result in failure of the bioretention area. The following are key stages in the construction sequence that are important for review:

- Verify the actual contributing drainage area (CDA) boundaries and that the CDA is adequately stabilized and/or secondary erosion control measures installed around perimeter of bioretention or inlet blocked during installation
- Confirm inlet and outlet elevations
- Confirm inflow actually captures runoff
- Check quality of filter media and that it meets specifications
- Make sure stone is washed and not laden with grit and fines
- Check underdrain elevations, slope, pipe connections, perforations and caps
- Confirm final ponding depth and proper grading and stabilization of side slopes
- Conduct full inundation test to inspect underdrain/outflow function (sinking and final grades)

Sometimes it is not possible to get an inspector out to the site for each stage of the construction inspection process. Some communities have developed innovative ways to ensure that the bioretention facilities are being constructed properly. One community in particular requires digital photographs of the bioretention facility during critical points in the construction process to be submitted to the locality in lieu of an inspector's visit. However, this is usually employed on sites where the locality has inspected several facilities during construction and is sure that the contractor and crew have a full understanding of what is required during installation. Otherwise, onsite inspection by either municipal reviewers or certifying engineers is strongly recommended.

Additional Resources

For additional information on the proper construction sequence and sound construction practices for bioretention and other LID practices, please visit the Chesapeake Stormwater Network's website where you can watch the video ***LID Stormwater Construction Practices: A Guide to Proper Construction Techniques for contractors, local governments and involved homeowners.***

The video is available at the link below: <http://chesapeakestormwater.net/training-library/design-adaptations/stormwater-bmp-maintenance/>

The Center for Watershed Protection has created a BMP Construction Checklist as a supplement to their Post-Construction Guidance Manual. The checklists are designed to be used by stormwater program managers, design consultants, plan reviewers, inspectors, and parties responsible for maintenance and are available for free download from their website: www.cwp.org.

Section 3

Making Sure it Still Works: The Visual Indicators Framework

The framework relies on a series of simple visual indicators to rapidly assess the maintenance condition and hydrologic function of a bioretention area. Each indicator is associated with a series of numeric triggers to classify the maintenance condition of the practice, and used to quickly put together a punch list of actions to restore its original performance.

If the visual indicators thresholds indicate that the practice has severe maintenance problems (or a series of moderate ones), it receives a “failing” grade, and a more in-depth investigation is triggered to diagnose the cause of the maintenance problem and an action plan to fix it (**Section 6**).

The Overall Framework

The visual inspection framework should be employed during every stage of the lifecycle of a bioretention area, including:

- Construction Inspection
- Project Acceptance
- Maintenance Checkups
- Periodic Local Inspection
- BMP Performance Verification
- Forensic BMP Investigations

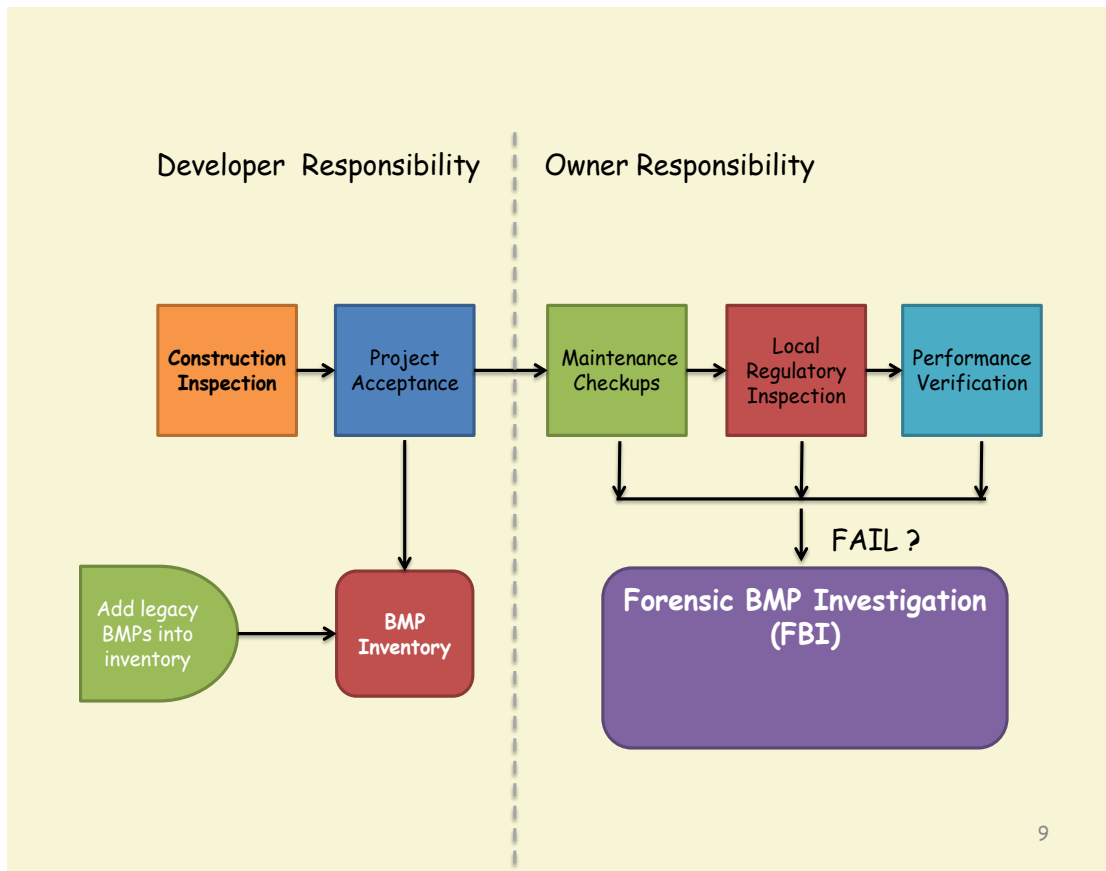

Figure 4. The Visual Inspection Framework

Each kind of inspection assesses the function of the bioretention area for a slightly different purpose. Figure 4 shows how the different types of inspection interconnect with each other to maintain the function of the bioretention area over its design life.

Construction Inspection

Construction inspection takes place during several specific points in the construction sequence of any bioretention area. It is a critical phase to ensure that the project is built to its design specifications, and any changes made in the field are acceptable. The construction inspection is normally performed by a trained professional that works for the local stormwater management review authority.

Project Acceptance

Project acceptance is a visual inspection that takes place about 12 months after the construction phase is over to make sure it is still working and meeting its landscaping objectives. If so, the practice is accepted by the local stormwater management review authority and any remaining performance bond is released and the maintenance responsibility is shifted to the property owner. Many communities may want to extend the duration of the performance bond until the project is finally accepted (or at least

require a care and replacement warranty for the landscaping). For more detail on project acceptance inspections, refer to **Section 5**.

Maintenance Checkups

Routine maintenance checkups occur 2-4 times a year as part of a regular maintenance visits and are used to immediately correct minor maintenance problems. The checkups are also used to provide quality control on maintenance activities, determine whether the landscape contractor needs to schedule a follow up visit to repair moderate maintenance problems and alert owners about any severe maintenance problems that require the attention of a more qualified stormwater professional. The use of visual indicators in routine maintenance checkups is discussed in **Section 5**.

Local Regulatory Inspection

Routine inspections of bioretention area may be required as part of a local MS4 permit and usually occurs once every 3-5 years, as designated by the state permit authority. They are conducted to ensure that the BMP is in regulatory compliance, which is defined as being properly maintained and functioning as designed. A routine inspection is conducted by a trained individual as defined by the local permitting agency. More information can be found in **Section 5**.

Performance Verification

Performance verification inspections occur if the BMP is being used to achieve pollutant reductions needed to help meet load allocations under a local and/or Bay-wide TMDL. This rapid inspection is done in conjunction with the local regulatory inspection to verify that the BMP still exists, is adequately maintained and is operating as designed. Verification inspections will typically occur once every other MS4 permit cycle (or about every 5 to 10 years). More information about verification inspections can also be found in **Section 5**.

Forensic BMP Investigation

A Forensic BMP Investigation, or “FBI”, is employed to diagnose why a practice is failing or has failed, and then come up with a plan to bring it back into compliance. These specialized assessments require a skilled stormwater professional to find and fix any severe maintenance problems discovered at a bioretention area. More details on the different methods to conduct a FBI can be found in **Section 6**.

The remainder of the sections in this technical bulletin walks through a detailed description of the different inspection categories.

Section 4 Visual Indicators for Bioretention

The visual indicators approach allows for a rapid assessment of the bioretention in 10 to 30 minutes by following a prescribed sequence of items to look for. Each of these ‘visual indicators’ is assessed based on a set of numeric triggers and assigned a grade of Pass, Minor, Moderate or Severe. This assessment results in a punch-list of maintenance tasks to be conducted in order to bring the bioretention area up to speed or in the case of a ‘severe’ rating, requires a forensic BMP investigation.

Table 9 outlines the 18 visual inspection indicators used for bioretention and identifies which types of inspections they generally apply to.

No.	INDICATOR	Construct	Accept	Maintain	Verify	FBI
1	Inlet Obstruction		X	X	X	X
2	Erosion at Inlet		X	X		X
3	Pretreatment	X	X	X		X
4	Structural Integrity, Safety Features		X	X		X
5	Surface Area	X	X	X		
6	Side slope Erosion		X	X		X
7	Ponding Volume	X	X	X	X	X
8	Bed Sinking		X	X	X	X
9	Sediment Caking		X	X	X	X
10	Standing Water		X	X	X	
11	Ponding Depth	X	X	X	X	X
12	Mulch Depth/Condition	X	X	X	X	
13	Trash			X		
14	Bed Erosion		X	X		
15	Vegetative Cover	X	X	X	X	X
16	Vegetative Condition		X	X		X
17	Vegetative Maintenance		X	X		
18	Outlets, Underdrains, Overflows	X	X	X	X	X

Applying the visual indicators during an inspection is best done in a prescribed sequence to systematically evaluate the bioretention area. Each of the indicators has been assigned to a “zone” or area within the bioretention area that corresponds with the sequence that the inspector would follow during assessment:

- Inlet zone
- Side slope zone
- Bed zone

- Vegetation zone
- Outlet zone

Figure 5 shows where the five different inspection zones are located within a typical bioretention area.

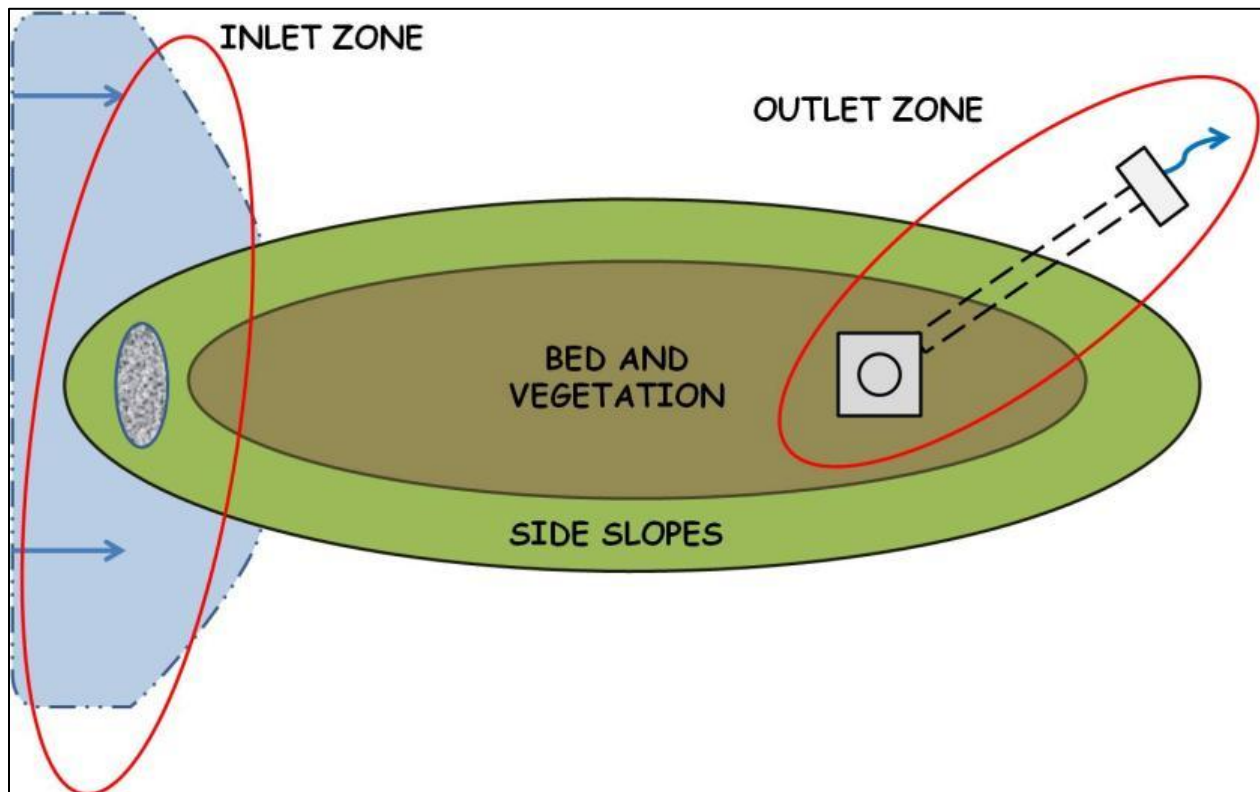

Figure 5. An overhead shot of a typical bioretention area with the inspection zones

Although each of the indicators should be assessed during an inspection, often an inspector will be able to immediately see any key trouble spots occurring with the bioretention. These *primary* or key indicators can inform the inspector instantly whether the bioretention is operating on a most basic level. Once these key indicators have been reviewed the inspection can proceed to assess the remaining indicators. The key indicators for a bioretention area are:

- Erosion within the bioretention
- Standing water anywhere in the basin
- Sediment or debris blocking inlets or outlets and causing
- Lack of or inappropriate vegetation

By assessing the individual components of the facility in this manner, it is possible to comprehensively yet rapidly evaluate the functionality of the entire bioretention area.

Tools for Visual Inspections

For any visual inspection there is a standard process and set of equipment that can help facilitate the process. It is beneficial to have a whiteboard and a digital camera to note observations in the field and document the inspection. For inspecting the facilities from the ground surface, there are many different tools that can be of benefit, the most necessary of which are listed in Table 10.

Table 10 Tools to Bring When Conducting Inspections	
<p><i>White board and digital camera: Used to note observations made in the field and rapidly record them</i></p>	<p><i>Manhole lifting device (i.e., pick, hand hook, etc): Used to open manholes or other structures associated with the bioretention area</i></p>
<p><i>Various wrenches (channel lock wrench, socket wrenches): Used to open observation pipes, monitoring wells etc.</i></p>	<p><i>Soil auger: For investigating soil conditions at a site and the soils ability to infiltrate</i></p>
<p><i>Measuring tape & 100' tape: Used to measure the surface area and depth</i></p>	<p><i>Shovel and rake: Used to inspect the mulch and media of the bioretention</i></p>

Other tools that may come in handy:

- Dip-sticks (chimney stick): To measure sediment
- Plant ID Sheet: To identify native and invasive species
- As-builts/site plans
- Safety vests
- Bug spray
- Flashlight for inspecting observation wells, cleanout pipes and other dark areas
- Authorization letter

More specialized tools and equipment are needed for routine maintenance checkups and forensic BMP investigations.

Visual Indicators Profile Sheets

Appendix A provides a series of profile sheets outlining each of the each of the visual indicators used to inspect bioretention areas. Each profile sheet describes the visual indicator, its purpose, pictures demonstrating the different grading categories, the maintenance triggers and the corresponding task or investigation needed to maintain or repair the facility. There is also a checkbox on the left hand side of each profile sheet that indicates to which inspection category the visual indicator can be applied.

Punch List Tool

CSN is currently working on the development of a spreadsheet based tablet tool that would create an automatic punch list of immediate and follow up maintenance tasks that need to be performed as a result of the inspection. This tool is under development and is expected to be completed in the summer 2013.

Section 5 Inspections and Maintenance

5.1 The Establishment Phase and Final Inspection

Project acceptance for bioretention is a visual inspection that takes place during the landscape establishment phase, typically 12 months after installation. The inspection is used to determine whether the locality will accept the facility, and release any remaining performance bonds*. The inspection is needed to ensure that the practice and landscaping are acceptable and functioning as designed.

This is a critical phase, since many bioretention areas will encounter some problems in the first year, particularly in establishing vegetation. Certain unforeseen weather events such as severe winters or extreme drought may make it hard for the vegetation to thrive.

The inspection is normally conducted for the local stormwater management review authority by either an engineer or a landscape architect at the culmination of the construction process, at which time the maintenance responsibility is shifted over to the property owner or responsible maintenance entity (Figure 6).



Figure 6. The Project Acceptance Process

The landscape establishment phase extends through the first growing season, and is usually covered by a landscape care and replacement warranty therefore this inspection should be completed before the plant warranty ends.

Inspectors use the full range of the 18 visual indicators discussed in **Section 4** to decide whether to accept the facility. The bioretention area should be inspected after a decent

sized storm to ensure it is operating correctly for the design storm and bypassing larger events.

Some typical tasks to accomplish during the establishment phase include:

- Regular watering if it has not rained in two weeks
- Spot re-seeding and removal/replacement of dead plants
- Remove any sediment accumulation at inlets or the bed
- Repair erosion on side-slopes
- Perform any minor or moderate maintenance tasks, as triggered by any visual indicator.
- Correct any severe maintenance problems in response to a forensic BMP investigation.

The inspector should certify that the desired vegetative cover has been achieved, confirm that the ponding depth and volume meet the design specs, and determine whether a practical overflow exists. Based on the results, the inspector may also recommend changes to the frequency of future inspections in the landscape maintenance contract to achieve the desired "level of service" for the facility.

Once a facility passes the final inspection, the designer should submit an "as-built" construction plan and local program staff should enter the GPS coordinates into the local stormwater maintenance tracking system. As-builts for a bioretention area should include taking digital photos and recording GPS coordinates for future verification. At this time, the local review authority can release the performance bond.

The final step is to hand off the facility to the owner, ensure a landscape maintenance contract or agreement is executed, and that its key provisions are understood by both the owner and the contractor.

*Please note some localities may not have the legal authority to hold a performance bond for a full twelve months after the bioretention facility has been constructed. But localities should be cognizant of the importance of the vegetation in the pollutant reduction capabilities of a bioretention system and thus should wait as long as legally possible before final approval to ensure a good vegetative cover of the facility.

5.2 Bioretention Maintenance Regime

It can be tempting to prescribe a specific list of maintenance tasks and a fixed schedule to perform them, but in reality most maintenance tasks are performed on demand based on what the inspector/maintainer actually sees. The maintenance regime for an individual practice depends on the desired level of service or amenity, visibility, development intensity and owner preferences. Other factors, such as extreme rainfall events, hard winters and extended droughts, can strongly influence maintenance needs from year to year.

At a minimum, visit the bioretention area at least twice during the growing season to see what needs to be done immediately during the inspection (with hand tools), or schedule a follow up visit to fix any moderate maintenance problems. Table 11 shows a general summary of common maintenance tasks that should be anticipated with any facility, with the proviso that the frequency that they will need to be performed will differ for each facility.

Maintenance Tasks	Frequency
<ul style="list-style-type: none"> • Mow grass filter strips and any intended turf cover in bioretention area • Check curb cuts and inlets for any accumulated sediment, leaves, and debris that may block inflow • Remove sediment in pre-treatment cells and inflow points 	Mowing: Approximately 6 times a year
<ul style="list-style-type: none"> • Spot weeding, trash removal, and mulch raking 	Twice during growing season
<ul style="list-style-type: none"> • Add reinforcement planting to maintain desired the vegetation density and/or split out perennials to increase plant cover. • Remove invasive plants using recommended control methods • Remove any dead or diseased plants • Stabilize the contributing drainage area to prevent erosion • Prune trees and shrubs to reduce "bushiness" 	As needed
<ul style="list-style-type: none"> • Conduct a maintenance inspection 	Annually
<ul style="list-style-type: none"> • Perform facility "make-over" to maintain intended landscaping regime and address any moderate or severe maintenance problems detected during routine inspections 	Once every 5 to 7 years

¹ loosely adapted from WVDEP Stormwater Design Manual (2012).

Additional Resources

For additional information on how to conduct routine maintenance of LID practices including bioretention and what critical factors need to be checked to make sure they are operating as designed please visit the Chesapeake Stormwater Network’s website where you can watch the video **Stormwater BMP and LID Maintenance: A Guide to Proper Maintenance Practices for Local Government Staff and Landscapers** available at the link below: <http://chesapeakestormwater.net/training-library/design-adaptations/stormwater-bmp-maintenance/>

Montgomery County Department of Environmental Protection has also created a series of fact sheets on maintenance of LID practices which are free for download and can be accessed here:

http://www6.montgomerycountymd.gov/dectmpl.asp?url=/content/dep/water/stormwaterfacility_new.asp#ESDLIDfactsheets

5.3 Regular Maintenance Checkups and Repair

Routine maintenance checkups occur 2-4 times a year as part of a regularly scheduled maintenance visit and are necessary in order to provide quality control on maintenance activities and/or to alert owners of any major problems that may be developing. The purpose of a routine maintenance checkup is to “catch” minor problems before they turn into more serious problems. The checkup is usually conducted by the same landscape contracting company that provides ongoing maintenance or the property manager (Figure 7).

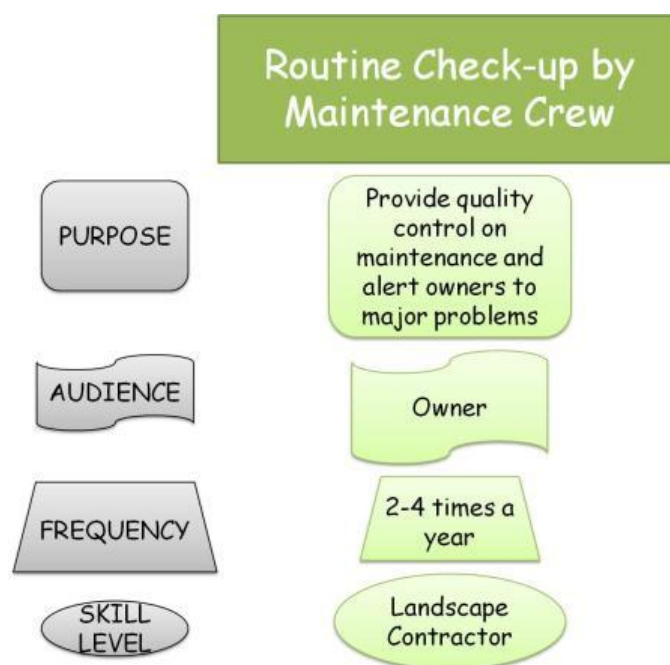

Figure 7: Key Elements of Routine Check Up by the Maintenance Crew

The other key purpose of the checkup is to train the crew so they can figure out what immediate maintenance tasks to perform during their visit, and whether a follow-up visit needs to be scheduled to correct any moderate maintenance problems that are encountered (i.e., that may require re-mulching, media replacement, spot repairs). If a follow-up visit is warranted, the crew should take notes on the materials and equipment needed to perform the repairs.

If the crew discovers a severe maintenance problem during their visit, they should flag it in their notes, and make sure to notify the owner or local stormwater authority that a more skilled inspector needs to perform a forensic BMP investigation (**Section 6**).

Additional Resources

For additional information on how to conduct routine maintenance of LID-type stormwater management practices including bioretention and commonly encountered maintenance problems with potential solutions for remediating them please visit the Chesapeake Stormwater Network's website where you can watch the video ***Stormwater BMP and LID Maintenance: A Guide to Proper Maintenance Practices for Local Government Staff and Landscapers*** available at the link below: <http://chesapeakestormwater.net/training-library/design-adaptations/stormwater-bmp-maintenance/>

5.4 Local Regulatory Inspections

Local regulatory inspections are conducted to ensure the practice is properly maintained and functioning as originally designed. Most regulatory inspections are done by the local governments to satisfy their MS4 permit requirement to inspect all the practices in their local BMP inventory to make sure they are still in regulatory compliance.

The required interval for performing regulatory inspections differs among the Bay states, but typically ranges from 1 to 5 years. The inspections are typically performed by local government inspectors, although it is increasingly common to hire private contractors to perform the service (Figure 8).

The basic technique is to assess the facility using the visual indicators, but the inspector will also look more closely at construction drawings and ensure that other connected stormwater practices, both above and underground, are functioning properly. If the inspector finds that facility has no or only minor maintenance problems, the facility passes, and is considered in compliance. The inspector enters the data into the local BMP tracking database, and moves on to assess the next practice.

On the other hand, if the inspection reveals more than two moderate maintenance problems or a single severe maintenance problem, the facility is deemed to fail. The inspector then sends the owner a letter indicating that their facility is non-compliant (and the reasons why), and gives them a specified interval to make the needed repairs. In some cases, they may also provide a list of qualified/certified maintenance contractors that can assess the problem and actually perform the repairs.

If the owner fails to make the repairs by the deadline, there may be enforcement actions. The nature and severity of the enforcement actions differ in many Bay communities, but may include fines, liens on property, loss of stormwater utility discounts, or direct billing to the owner for third party repairs.

Several local maintenance enforcement options are outlined in Technical Bulletin 11, most start with a heavy dose of education as to why the practice is needed to protect the Bay, and how it is supposed to work.

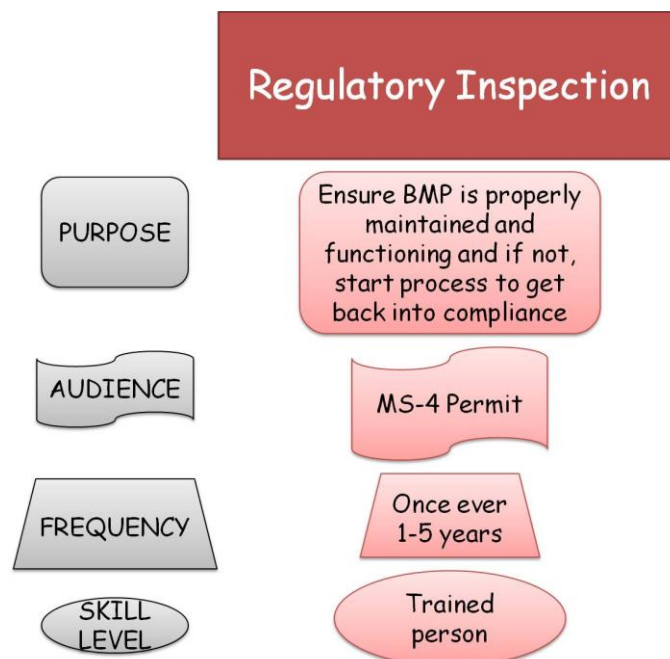

Figure 8. Key Components of Local Regulatory Inspections

5.5 BMP Performance Verification

Another kind of regulatory inspection is needed to verify that the bioretention area still exists, is adequately maintained and is operating as designed, and therefore can continue to earn its pollutant reduction credits, in the context of either a local or Bay-wide TMDL.

The performance verification as seen in Figure 9 is conducted at the same time as the required local regulatory inspection using the same visual indicators but is only needed once every other permit cycle, as mandated in the local MS4 permit (typically every 9-10 years). Since the performance verification is "piggybacked" onto regularly scheduled regulatory inspections, it requires little or no additional work, just a different level of reporting.

In the Chesapeake Bay Watershed, BMP performance verification is required to continue to receive pollutant reduction credits that help meet the Chesapeake Bay Total Maximum Daily Load (TMDL).

For more information on verification protocols, visit our website and download the CBP Urban Stormwater Workgroup's Final Recommended Principles and Protocols for Urban Stormwater BMP Verification here: <http://chesapeakestormwater.net/bay-stormwater/baywide-stormwater-policy/urban-stormwater-workgroup/>. Individual states will be rolling out their specific BMP verification requirements in the next year or so, so make sure to consult with your state stormwater agency.

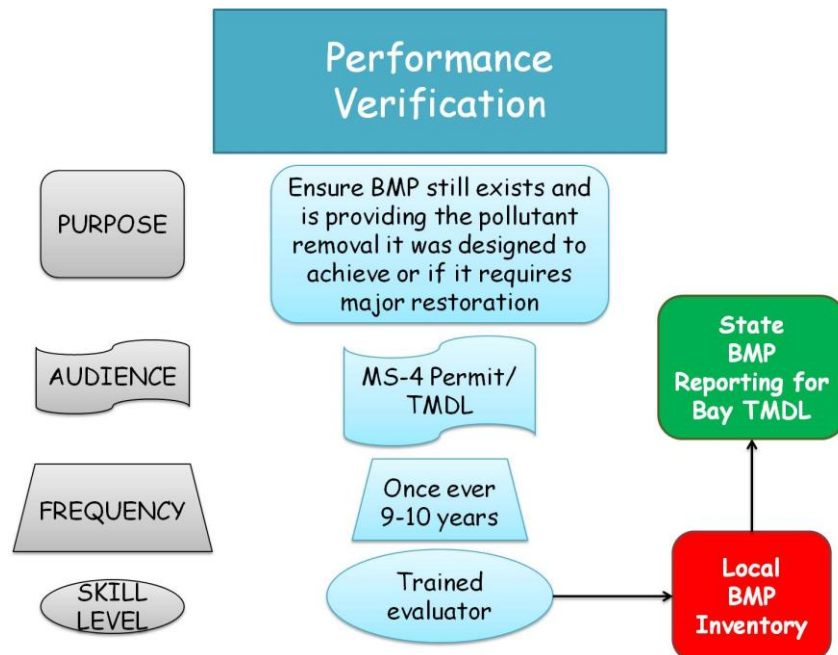

Figure 9. Key Components of BMP Performance Verification

Performance verification uses a subset of the list of visual indicators that assess the hydrologic function and pollutant removal capability of the bioretention area, by answering three simple questions:

1. Does it still physically exist? i.e., can you find it and are the conditions and cover in the contributing drainage area still the same?
2. Is it still operating to treat and reduce runoff as it was originally designed?
3. Is the maintenance condition sufficient to still support its pollutant reduction functions?

Table 12 indicates the 9 specific visual indicators that are used to answer the questions above. A "severe" maintenance problem detected for one or more of these indicators, means that the facility fails and will lose pollutant removal credits unless it is brought back into compliance.

Table 12. Key Visual Indicators for Performance Verification		
Hydrologic Condition	Severe Bed Sinking	Runoff moves too quickly through the bioretention
	Severe Inlet Obstruction	Runoff is not able to get into the bioretention
	Standing Water	Runoff is not fully being treated
	Loss of Surface Ponding Capacity	Runoff is not fully being treated
	Severe Erosion at Outlet	Runoff is bypassing the bioretention

Maintenance Condition	Inadequate Vegetative Cover	Runoff is not fully being treated
	Severe Pretreatment Failure	Reduced longevity of the bioretention
	Severe Inlet or Side Slope Erosion	Sediment delivery to filter bed

Section 6 Forensic BMP Investigations

When a bioretention area cannot meet the minimum performance thresholds (i.e., classified as having severe maintenance problems), it is time for a more in-depth assessment to diagnose the causes of failure and prescribe an effective repair, which is known as a Forensic BMP Investigation, or “FBI”.

The party responsible for conducting the FBI will often be the same one that has legal responsibility for maintenance and repairs of the facility. Therefore, it may not be appropriate for a FBI to be performed by the same party that performs the routine inspections.

The purpose of the FBI is to diagnose why the bioretention is not working and how it can be fixed. If a bioretention is considered to be “failing” due to one or more severe indicators then most likely a follow-up visit by an engineer, landscape architect, or contractor with relevant project experience will be required. Several indicators can trigger an FBI, as shown in Table 13.

No.	INDICATOR	Status
1	Severe Inlet Obstruction	Most runoff cannot enter the facility
3	Inadequate or Lack of Pretreatment	Severe accumulation of sediment in facility
4	Structural Integrity	Facility or adjacent infrastructure at risk of failure
2, 6, 14	Severe Inlet Erosion, Sideslope or Bed	A foot or more of gully erosion
5, 7, 11	Severe Design Departures	More than 25% departure from design assumptions for surface area, ponding depth and/or contributing drainage area
8	Severe Bed Sinking	A foot or more of localized bed sinking and/or sediments observed in underdrain
9	Severe Sediment Caking	More than two inches of deposition in the facility
10	Severe Standing Water	More than 3 inches of ponding 72 hours after rain
15	Severe Vegetative Cover	35% or less vegetative cover

The goal behind the FBI approach to bioretention problems and repairs is to quickly identify why the bioretention facility is not working and how it can be fixed instead of turning the failed facility into an expensive engineering project. FBIs only occur when a field inspection shows that the bioretention facility is not functioning as designed.

Indicator #1: Severe Inlet Obstruction



Problem: Severe accumulation (greater than 3”) of sediment or debris at the inlet so that most of the runoff cannot enter the bioretention facility. Photo on the left shows severe sediment build-up in the crevices between the stones.

Solution: Locate source of the sediment, mitigate and evaluate the need for enhanced pretreatment. Remove riprap, stone, or mulch contaminated with sediment. Clean all sediment from the inflow area. If riprap is used, clean off and replace with original stone, supplemented as needed. If stone or mulch is used, add new material to attain appropriate elevations and flow characteristics. Check inlet elevations and adequate drops from pavement edge to inlet channel. Inlet may need to be reshaped to have adequate drop or slope to filter bed surface so it is not prone to routine clogging. Arrange for more frequent cleaning of sediment from inlet.

Indicator #3: Inadequate or Lack of Pretreatment



Problem: Severe accumulation of sand or sediment within the bioretention facility or the pretreatment area. Evidence of standing water in the pretreatment area or bypass of the bioretention facility altogether.

Solution: Locate the source of the sediment, mitigate and evaluate the need for enhanced pretreatment, corrected or more frequent maintenance, and/or design remediation. In many cases, ensuring that maintenance personnel are removing minor amounts of sediment while performing routine maintenance can help correct the lack of pretreatment.

Indicator #4: Structural Integrity



Problem: Curbs, pavement, or drainage structures are damaged to the point where it impairs the function of the bioretention.

Solution: Schedule a visit by a project estimator with relevant project experience to develop a solution and conduct repairs. Depending upon the type of structure involved, such as with a retaining wall, an engineer may need to be consulted to design a solution.

Indicators #2, #6, #14: Severe Inlet, Side Slopes or Bed Erosion



Problem: A foot or more of gully erosion at the inlet or in the bed of the bioretention facility. Greater than 3” of erosion in the side slopes.

Solution: In general, the solution is to determine the cause of the erosion and repair it. This differs depending on where the erosion is occurring. At the inlet, it may be necessary to implement protection measures to ensure that runoff is being dissipated and prevented from entering the facility in a concentrated flow or to extend the protection onto the flat bed area. On the side slopes of the bioretention, it may be necessary to re-grade and evaluate the topsoil and vegetation to determine if there is sufficient vegetative cover to stabilize the slopes. When erosion occurs within the bed of the facility, it is necessary to evaluate the flow patterns and the condition of the bed materials to determine if they are appropriate for the runoff volume. Supplemental protection may be required to match the flow conditions. Soil media should be utilized for any bed repairs to ensure the intended flow characteristics are preserved.

Indicators #5, #7, #11: Severe Design Departures

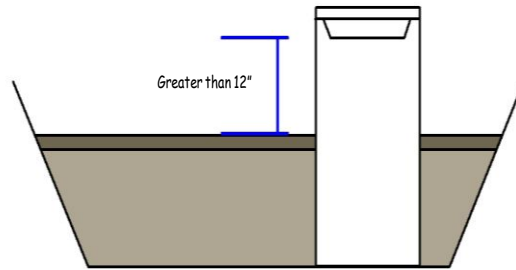

Problem: A greater than 25% departure from the design assumptions for surface area, storage, ponding depth or contributing drainage area.

Solution: Conduct a topographic survey and consult site plans to determine the cause and degree of the deviation. In the case of ponding depth, adjust grade by removal or addition of mulch and/or media. In the case of surface area and storage, re-grade the facility to meet design areas and volumes. If increasing the surface area, evaluate the dewatering capabilities of the existing soil media area and adjust accordingly. In the case of changes to the drainage area, delineate the actual CDA, re-compute the facility performance, and modify as needed to meet minimum design criteria.

Indicator #8: Severe Bed Sinking

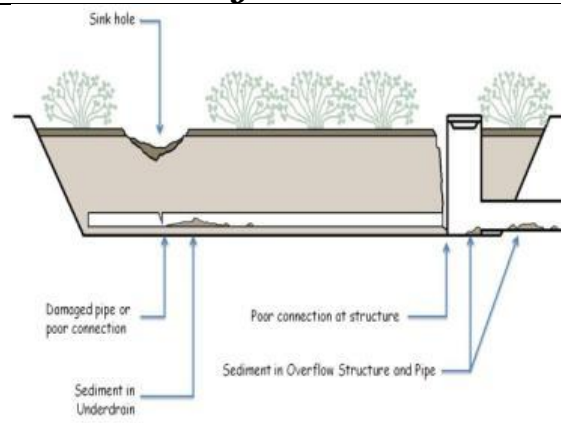

Problem: Greater than 1' of localized bed sinking and/or sediment is observed in the underdrain or overflow. The discovery of sediment in the underdrain or overflow structures indicates the movement of sediment through the facility.

Solution: Severe bed sinking is often a result of breached material layers, poor connections, or damaged pipes within the bioretention facility. Conduct a test pit excavation to provide detailed visual examination of subsurface conditions. Test pitting should occur by hand to minimize compaction of the bed. Make sure dissimilar materials are kept separate and not cross contaminated during the test pitting operation. Be prepared to repair the system (i.e., with new filter cloth or choker stone) to full functionality at test pit completion. Remove mulch, and evaluate the soil media for sediment and/or discoloration throughout the profile. Once through the soil media, cut filter cloth or hardware cloth or, if choker stone is used, remove the next level of stone to gain access to the underdrain stone. Look for voids, loss of material, staining or failure of any of the layers. There should be no evidence of soil media at the underdrain stone layer. If needed, excavate to the underdrain pipe and check pipe and joint condition. All materials should be replaced in appropriate layers to ensure full intended functionality without cross contamination of the individual material layers.

Indicator #9: Severe Sediment Caking



Problem: Greater than 2" of sediment deposition within the bioretention facility or a hard-pan surface due to sediment sealing the surface of the mulch or soil media.

Solution: Sedimentation in the bioretention facility can result from a variety of causes. It can be from a sediment source in the contributing drainage area or from erosion within the facility itself. Conduct a full cleanout of sediment, mulch and soil media in the affected area to depth of 6" within the bed surface or to the point where sediment is no longer observed in the soil media. Identify source of sediment and work to remediate it.

Indicator #10: Severe Standing Water



Problem: Standing water in the bioretention facility 24-48 hours after a design storm indicates the facility is not functioning as designed.

Solution: Confirm that the underdrain pipe is perforated and not blocked. Pump down the water and conduct a test pit excavation (as described in Indicator #8) to investigate the mulch, soil media and possible presence of filter cloth (which should NOT be used a separation barrier between the soil media and underlying underdrain stone layer). All pumping should be discharged through a geotextile bag. Evaluate the condition of the materials and look for signs of sediment and saturation in the soil media profile. First, determine if sediment is clogging the surface of the mulch or soil media. Then determine if the soil media contains too many fines with either a simple field test or laboratory analysis. If filter cloth is present, determine if it is functional and of the correct specification (non-woven geotextile fabric with a flow rate of > 110 gal./min./sq. ft.). If choker stone is present, determine if the in-place stone matches the specification (typically #8 or #89 washed gravel).

Indicator #15: Severe Vegetative Cover



Problem: When the bioretention facility suffers from less than 35% vegetative coverage, dead or diseased plants or overgrown with invasive species.

Solution: Evaluate the cause of the plant failure (soils, species, disease, design) and create a new planting plan based on the outcomes of those findings. The analysis of the plant material should include a soil test to determine if critical parameters, such as pH, organic matter, and moisture are a match for the intended species. For invasive species control, design and implement an eradication plan. Following the remediation, ensure that appropriate plant maintenance, such as mulching, fertilizing, weeding, disease intervention, etc. occurs to avoid a re-occurrence of the failure.

References Cited

CWP and Chesapeake Stormwater Network (CSN). 2008. *Technical Support for the Baywide Runoff Reduction Method*. Baltimore, MD www.chesapeakestormwater.net

Gillette, A. 2013. Personal communication. Landscape Architect. Low Impact Design Studio. January, 2013.

Urban Stormwater Workgroup (USWG). 2012. Recommendations of the Expert Panel to Define Removal Rates for New State Stormwater Performance Standards. 4.30.2012. Chesapeake Bay Program. Annapolis, MD.

West Virginia Department of Environmental Protection (WVDEP). November 2012. West Virginia Stormwater Management and Design Guidance Manual.

Appendix A
Visual Indicator Profile Sheets
for Bioretention Inspections

#1

INLET OBSTRUCTION

INLET ZONE

Construction Inspection

Project Acceptance ✓

Routine Maintenance ✓

Routine Inspection ✓

Performance Verification ✓

Description: Investigate the inlet for sediment, debris or turf that obstructs runoff from getting into the bioretention area.

PASS



This inlet is clean and in good condition.

MINOR



There is a minor amount of sediment and/or debris build up at the inlet.

MODERATE



The moderate amount of sediment accumulation at this inlet indicates an entry problem that could lead to a risk of blockage.

SEVERE



Sediment build-up or staining indicates that water is ponding and a significant amount of runoff is not getting into the facility.

	MAINTENANCE TRIGGER	TASK/INVESTIGATION
PASS	Free of sediment/debris	None
MINOR	Less than 1" of sediment potentially blocking inlet	Immediately clear inlet of accumulated sediment
MODERATE	1-3" of sediment blocking the inlet	Schedule next visit to remove sediment
SEVERE	3 or more inches of blockage preventing most storms from getting into the bioretention area	Schedule next visit to remove sediment and conduct an investigation of source CDA

#2

INLET EROSION

INLET ZONE

Description: Investigate the inlet for evidence of channelized erosion or scour. This indicator determines if upland erosion is delivering sediment to the bioretention area, and may also indicate improper elevations or a preferential flow path within the facility.

- Construction Inspection
- Project Acceptance ✓
- Routine Maintenance ✓
- Routine Inspection ✓
- Performance Verification

PASS	MINOR
 <p><i>Inlet (stone channel) in good condition, no evidence of erosion.</i></p>	 <p><i>Surface runoff from parking lot causing minor erosion of mulch at inlet.</i></p>
MODERATE	SEVERE
 <p><i>Concentrated flow results in moderate erosion at inlet. Investigation into cause is necessary as could result in more severe condition.</i></p>	 <p><i>Scour is occurring at the inlet indicates a possible design flaw.</i></p>

	MAINTENANCE TRIGGER	TASK/INVESTIGATION
PASS	No evidence of erosion at inlet.	None
MINOR	3" – 6" of gully erosion	Rake, mulch and replace media
MODERATE	6" – 12" of gully erosion	Schedule visit to stabilize inlet with fabric or stone
SEVERE	More than 1' of gully erosion	Do above, but investigate CDA for sediment sources





#3

PRETREATMENT

INLET
ZONE

- Construction Inspection ✓
- Project Acceptance ✓
- Routine Maintenance ✓
- Routine Inspection ✓
- Performance Verification

Description: This indicator evaluates whether pretreatment exists at the facility and whether it needs to be cleaned out. Pretreatment is necessary to trap sediment and debris before it reaches and clogs the filter bed. Pretreatment methods vary by bioretention design but the visual indicators approach would be similar for all.

PASS	MINOR
	
<p><i>This pretreatment measure is free and clear of sediment/debris.</i></p>	<p><i>Slight accumulation of sediment in the pretreatment cell.</i></p>
MODERATE	SEVERE
	
<p><i>Pretreatment measures needed at this facility. Sediment deposition has almost entirely clogged the inlet.</i></p>	<p><i>Lack of pretreatment or inadequate pretreatment has led to facility failure.</i></p>

	MAINTENANCE TRIGGER	TASK/INVESTIGATION
PASS	Free and clear of sediment or debris	None
MINOR	Pretreatment capacity is within 10% of design	Remove and dispose sediment from pretreatment cell
MODERATE	As much as 50% pretreatment capacity has been lost or no pretreatment provided	Schedule visit to restore /create pretreatment capacity
SEVERE	Loss of pretreatment capacity (or absence of pretreatment) is compromising facilityConduct FBI (Section 6)	

#4

STRUCTURAL INTEGRITY

INLET ZONE

Construction Inspection





Project Acceptance ✓

Routine Maintenance ✓

Routine Inspection ✓

Performance Verification

Description: This indicator assesses whether the facility is causing damage to adjacent pavement and curbs. Flows, scour or water seepage are usually the cause of the damage.

PASS	MINOR
	
<p><i>Surrounding curbs and pavement are in good condition.</i></p>	<p><i>Some pavement cracking occurring in surrounding pavement.</i></p>
MODERATE	SEVERE
	
<p><i>Inlet elevation drop too steep leading to erosion within the facility. Reinforcement needed immediately to prevent collapse.</i></p>	<p><i>Major problems with adjacent curbs and/or pavement. Design repair needed.</i></p>

	MAINTENANCE TRIGGER	TASK/INVESTIGATION
PASS	Surrounding curbs and pavement in good condition	None
MINOR	A few cracks or isolated deterioration but does not impair facility or infrastructure function	Note in project file
MODERATE	Moderate flaws in structural integrity that are resulting in the facility not functioning properly	Schedule visit to assess and develop repair strategy
SEVERE	Curbs or pavement are damaged and impairing function.	Schedule a visit by project estimator or contractor to conduct repairs

#5

SURFACE AREA

PERIMETER ZONE

Construction Inspection ✓

Project Acceptance ✓

Routine Maintenance ✓

Routine Inspection ✓

Performance Verification

Description: This indicator determines whether the bioretention facility still matches the original surface area of the design. Bioretention facilities that are undersized can lead to the need for more frequent maintenance and repairs.

PASS



The surface area of this bioretention facility slightly deviates from the original design but not significantly to impact the pollutant reduction functions of the facility.

SEVERE



Inspectors measure the surface area of a bioretention facility.



The surface area of this bioretention facility significantly deviates from the original design.

	MAINTENANCE TRIGGER	TASK/INVESTIGATION
PASS	Surface area matches design	None
MINOR	Surface area 5-10% different from design	Note in project file.
MODERATE	Surface area 10-25% different from design	Check to see if easement exists
SEVERE	Surface area >25% different from design	Conduct analysis to see if surface area can be increased, if performance bond is still active, and if facility is within limits of easement

#6

SIDE SLOPE EROSION

PERIMETER ZONE

Description: This indicator evaluates the stability of the side slopes of the bioretention area which should be 3:1 or flatter. Erosion of the side slopes can indicate a problem with grading or incoming runoff velocities and may require better inflow protection measures.

Construction Inspection

Project Acceptance ✓

Routine Maintenance ✓

Routine Inspection ✓

Performance Verification

PASS



There is no evidence of side slope erosion occurring in this bioretention.

MINOR



There is minor side slope erosion occurring as a result of overland flow of water into the bioretention facility.

MODERATE



The side slopes in this bioretention are too steep which is causing moderate erosion.

SEVERE



Severe side slope erosion is occurring.

	MAINTENANCE TRIGGER	TASK/INVESTIGATION
PASS	No evidence of side slope erosion.	None
MINOR	Isolated rill erosion, less than 1"	Spot soil replacement and reseeding.
MODERATE	Gully erosion of 3" or less at several points on the slope	Schedule visit to fill gullies (and replant, stabilize), add inflow protection measures.
SEVERE	Gully erosion greater than 3" at any point	Investigate whether the gullies are formed by too much runoff.





#7

PONDING VOLUME

PERIMETER ZONE

Description: This indicator determines whether the facility is fully utilizing its design ponding capacity or is short-circuiting or not using full ponding depth for some other reason.

- Construction Inspection ✓
- Project Acceptance ✓
- Routine Maintenance ✓
- Routine Inspection ✓
- Performance Verification ✓

PASS	MINOR
	
<p><i>Runoff spreads evenly through the entire facility and uses the entire ponding depth</i></p>	<p><i>Water leaves the facility through the gap at the bottom of the outlet structure before having a chance to fill up the basin.</i></p>
MODERATE	SEVERE
	
<p><i>Water that enters the facility leaves before infiltrating into the filter bed.</i></p>	<p><i>Water is unable to enter the facility due to incorrect elevations.</i></p>

	MAINTENANCE TRIGGER	TASK/INVESTIGATION
PASS	Runoff fully utilizes entire ponding depth across the facility	None.
MINOR	Effective ponding volume within 10% of original design assumption	Note in project files.
MODERATE	Effective ponding volume is 25% less than design assumption	Schedule a visit to modify facility to increase ponding volume.
SEVERE	Effective ponding volume is >50% less than design assumption	Compare to original design to see if facility still conforms to ponding volume or CDA design assumption.





#8

BED SINKING

BED ZONE

Description: This indicator determines whether any localized depressions or sink holes are present within the bed of the bioretention facility. This could indicate potential underground problems with the soil media, filter cloth, the stone layer and/or underdrain.

- Construction Inspection
- Project Acceptance ✓
- Routine Maintenance ✓
- Routine Inspection ✓
- Performance Verification ✓

PASS	MINOR
	
<i>Even, flat bed, with no evidence of sinking</i>	<i>Minor, localized sinking occurring</i>
MODERATE	SEVERE
	
<i>Moderate, localized sinking occurring</i>	<i>Severe sinking occurring at overflow structure.</i>





	MAINTENANCE TRIGGER	TASK/INVESTIGATION
PASS	Bed is even with no depressions	None
MINOR	3-6" of localized bed sinking and/ or sediments observed in underdrain	Provide spot mulch and/or media refills, rake level
MODERATE	6"-12" of localized bed sinking and/ or sediments observed in underdrain	Schedule second visit to fill in depressions with mulch and/or media, and replant
SEVERE	>12" of localized bed sinking and/ or sediments observed in underdrain	Check underdrain/overflow for media/soil, and/or conduct test pit near the holes

#9

SEDIMENT CAKING

BED ZONE

Description: This indicator determines if sediment caking or deposits exist in the bed that could impair the performance of the facility. This could indicate a source of sediment in the CDA or problems with the pretreatment measures.

PASS	MINOR
	
<i>Bioretention in good condition. Free of sediment and caking.</i>	<i>Caking occurring on the bioretention bed surface.</i>
MODERATE	SEVERE
	
<i>Moderate sedimentation occurring.</i>	<i>Severe sedimentation occurring; bioretention most likely clogged</i>

	MAINTENANCE TRIGGER	TASK/INVESTIGATION
PASS	No evidence of sediment or caking on the bioretention bed	None.
MINOR	<1" of sedimentation or caking occurring within the facility	Rake and remove surface caking.
MODERATE	1-2" of sediment deposition occurring within the facility	Schedule a second visit to remove sediments and check pretreatment and CDA.
SEVERE	More than two inches of deposition in the facility	Conduct full cleanout to depth of 6" within bed surface. Identify and fix sediment delivery problem.

#10

STANDING WATER

BED ZONE

Description: This indicator determines if the bioretention facility is functioning properly. Bioretention facilities are designed to fully dewater in 48 hours, and should be free of standing water after as few as 12 hours after most storms. Standing water or evidence thereof indicates a problem within the facility.

Construction Inspection

Project Acceptance ✓

Routine Maintenance ✓

Routine Inspection ✓

Performance Verification ✓

PASS



Bioretention in good condition, no evidence of standing water.

MINOR



Saturated soils indicate presence of standing water.

MODERATE



1-3" of standing water after 72 hours

SEVERE



Standing water for more than 72 hours indicates facility failure

	MAINTENANCE TRIGGER	TASK/INVESTIGATION
PASS	No evidence of standing water	None.
MINOR	Saturated soils or evidence of obligate wetland plant species	Make a note, and check for at next maintenance visit.
MODERATE	1-3" of standing water after 48 hrs	Note as a potential risk for failure and schedule for more frequent inspection.
SEVERE	>3" of standing water after 48 hrs	Pump down, dig test pit, check fabrics.

#11

PONDING DEPTH

BED ZONE

Construction Inspection ✓

Project Acceptance ✓

Routine Maintenance ✓

Routine Inspection ✓

Performance Verification ✓

Description: This indicator determines whether the current ponding volume of the bioretention facility matches the design. Ponding areas that are too shallow are an indication that the bioretention does not provide the correct amount of storage whereas ponding areas that are too deep cause a safety and performance problem.

PASS

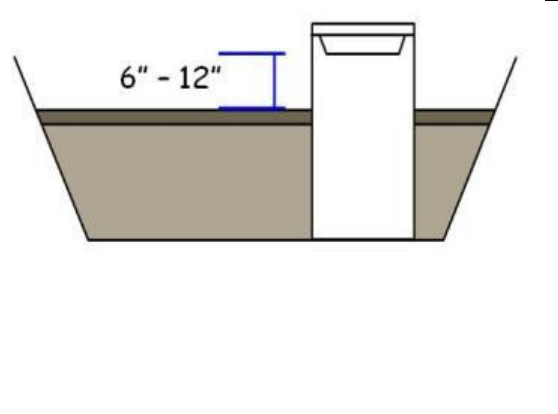

Ponding depth should be measured and compared to the original design. 6-12" is standard for most bioretention facilities (however ponding depth limits vary by state, check your state stormwater manual for guidance).

SEVERE



The ponding depth of this facility is significantly shallower than originally designed



The ponding depth of this facility is significantly deeper than as originally designed

	MAINTENANCE TRIGGER	TASK/INVESTIGATION
PASS	Ponding depth matches design	None.
MINOR	Less than 10% departure from design ponding depth of X inches (i.e., 12")	Note in project file.
MODERATE	Plus or minus 4" departure from design ponding depth	Remove mulch/media if too shallow; Add mulch/media if too deep.
SEVERE	More than 25% departure from design	FBI (Section 6)

#12

MULCH DEPTH/CONDITION

BED ZONE

Construction Inspection ✓

Project Acceptance ✓

Routine Maintenance ✓

Routine Inspection ✓

Performance Verification ✓

Description: This indicator assesses the mulch depth and condition in the bioretention area which should be 2-3” deep unless the bed has significant ground cover (>75%). This visual indicator also assesses that there isn’t too much mulch in the facility which could lead to nutrient leaching or the loss of ponding depth.

PASS	MINOR
	
<p><i>Bioretention in good condition. Good mulch depth and/or ground cover.</i></p>	<p><i>Slight displacement occurring. Replace mulch and/or add ground cover.</i></p>
MODERATE	SEVERE
 <p>Level of mulch – blocking curb inlet</p>	
<p><i>Level of mulch is blocking curb inlet.</i></p>	<p><i>10” of mulch indicates maintenance crew not aware of function of facility.</i></p>

	MAINTENANCE TRIGGER	TASK/INVESTIGATION
PASS	2-3” of mulch and more than 75% vegetative cover	None.
MINOR	1” or less of mulch or 65% ground cover	Schedule mulching for next visit
MODERATE	4-5” of mulch or no mulch and less than 50% vegetative cover	Add or remove mulch to design depth (2”-3”). And add more ground cover to meet passing grade
SEVERE	More than 6” of mulch or no mulch and < 35% vegetative cover	Add or remove mulch to design depth (2”-3”). And add more ground cover to meet passing grade

#13

TRASH

BED ZONE

Description: This indicator determines if the bioretention is filled with trash and needs to be cleaned out. Trash can block important parts of the bioretention like the inlets and outlets as well as take up valuable storage area.

Construction Inspection

Project Acceptance

Routine Maintenance ✓

Routine Inspection ✓

Performance Verification

PASS



Bioretention in good condition, no evidence of trash.

FAIL



Bioretention full of trash and needs to be cleaned out.

	MAINTENANCE TRIGGER	TASK/INVESTIGATION
PASS	Free of trash	None.
FAIL	Significant amount of trash	Remove trash and debris and dispose of appropriately.
CHRONIC FAIL	More than three major cleanouts a year	Evaluate drainage and surrounding area to see if there are any prevention opportunities (trash cans etc.)

#14

BED EROSION

BED ZONE

Description: This indicator determines whether erosion is occurring in what should be a flat bed facility. Bed erosion can be a sign of an undersized facility either due to poor design or changes in its drainage area.

Construction Inspection

Project Acceptance ✓

Routine Maintenance ✓

Routine Inspection ✓

Performance Verification

PASS



Bioretention in good condition – no bed erosion occurring.

MINOR



Minor bed erosion or displacement occurring as a result of a larger storm event.

MODERATE



Significant bed erosion occurring leading to a preferential flow path.

SEVERE



Severe bed erosion demonstrates that the bioretention may be undersized for the amount of volume it is receiving or pretreatment is needed

	MAINTENANCE TRIGGER	TASK/INVESTIGATION
PASS	Bed is flat and even	None.
MINOR	3-6" of rill erosion	Backfill with soil and cover, add mulch and rake.
MODERATE	6"-12" of gully erosion	Schedule visit to install measures to disperse flows more evenly, rake, backfill and mulch.
SEVERE	>12" of gully erosion	FBI (Section 6)

#15

VEGETATIVE COVER

VEGETATION
ZONE

Description: This indicator determines whether the facility is achieving the desired percentage of vegetative cover. Adequate vegetative cover is critical to reduce runoff and pollutants in a facility. Lack of vegetation can impair the pollutant uptake function of a bioretention area. This indicator can only be assessed during the growing season.

PASS



This bioretention has good vegetative cover.

MINOR



This bioretention has a few bare spots and could use either spot planting or the addition of mulch.

MODERATE



This bioretention has less than 75% vegetative coverage and is probably not functioning to its full potential

SEVERE



Vegetation is not growing in this bioretention as a result of it not being an environment conducive to vegetation or poor maintenance is occurring.

	TRIGGER	TASK/INVESTIGATION
PASS	Good vegetative cover, > 75%	None.
MINOR	Isolated bare spots (< 65% vegetative cover)	Split herbaceous materials, reseed, and add reinforcement plantings.
MODERATE	< 50% vegetative cover	Replant, schedule visit to do a major replanting.
SEVERE	< 35% vegetative cover	Investigate cause of plant mortality. Based on findings, design a revised planting plan for facility.

#16

VEGETATIVE CONDITION

VEGETATION
ZONE

Description: This indicator assesses the health of the vegetation planted in the bioretention facility and checks for the spread of invasive plants. Plants should be healthy and alive and match the original planting plan.

PASS	MINOR
	
<i>Plants alive and in good condition</i>	<i>Spot weeding needed.</i>
MODERATE	SEVERE
	
<i>Plants are dead or diseased in this bioretention facility.</i>	<i>This bioretention is overrun with invasive plants.</i>





	MAINTENANCE TRIGGER	TASK/INVESTIGATION
PASS	Plants alive and in good condition	None.
MINOR	Considerable weeding needed	Weed, replant
MODERATE	Some plants are dead or diseased or some invasive plants.	Determine the cause of plant mortality, replant
SEVERE	Significant plant mortality and/or takeover by invasive species. The objectives of the original planting plan are no longer being met.	FBI (Section 6)

#17

VEGETATIVE MAINTENANCE

VEGETATION ZONE

Description: This indicator assesses what level of vegetative maintenance is occurring at the bioretention area to maintain its function and appearance. The level of maintenance a bioretention facility receives depends largely upon its landscaping regime and landscaping regimes should be considered when contemplating maintenance (**Section 1**).

PASS	MODERATE
 <p><i>Well-maintained</i></p>	 <p><i>Tree and/or shrubs overgrown in facility; removal is needed</i></p>
MODERATE	SEVERE
	 <p><i>Major tree and/or shrub removal needed</i></p>

	MAINTENANCE TRIGGER	TASK/INVESTIGATION
PASS	Vegetation is being maintained per its landscaping objective	None.
MINOR	Bioretention is getting a bit bushy, needs some weeding or thinning.	Cosmetic weeding and pruning.
MODERATE	Too bushy, needs harvest of trees, shrubs, or herbaceous material to meet its landscaping objectives.	Schedule a second visit for mowing, tree thinning, and/or reinforcement plantings
SEVERE	Needs major tree/shrub removal	Bush hog the entire facility and replace vegetation.



#18

OUTLETS, UNDERDRAINS, OVERFLOWS

VEGETATION ZONE

Description: This indicator assesses whether the outlets, underdrains and/or overflows are clean, free of obstructions and are working properly. If the outflow device has sediment or debris in it, this is a sign of a more serious problem occurring within the facility.

- Construction Inspection ✓
- Project Acceptance ✓
- Routine Maintenance ✓
- Routine Inspection ✓
- Performance Verification ✓

PASS

<i>This underdrain is mainly free of sediment and debris.</i>
SEVERE

<i>This underdrain is clogged with sediment. Further investigation is needed to determine the cause of the problem.</i>

	MAINTENANCE TRIGGER	TASK/INVESTIGATION
PASS	Outflow device is free of sediment and debris	None.
MINOR	Nominal loss of pipe capacity	Pipe cleanout, flag to investigate during next inspection cycle
MODERATE	Significant loss of pipe capacity	Cleanout pipe and investigate cause.
SEVERE	Outflow device is completely clogged with sediment or debris	FBI (Section 6)

Appendix B

Visual Indicators for Other LID Practices

This appendix outlines proposed visual indicators for four additional LID practices that have a maximum contributing drainage area of 10,000 square feet:

- Grass Channels
- Filter Strips/Sheet flow to Buffer
- Permeable Pavement
- Subsurface Infiltration

Simpler visual indicators are being developed separately for smaller LID practices, such as on-lot residential disconnections and rain gardens.

B.1. Grass Channels

Grass Channels are vegetated open channels that are used as part of the stormwater conveyance system. Grass channels reduce runoff and manage pollutants by slowing the flow of stormwater through the channel and providing the opportunity for infiltration. Figure B-1 shows a schematic of a grass channel (WVDEP). Figure B-2 is a photo of a Grass Channel in “good condition”.

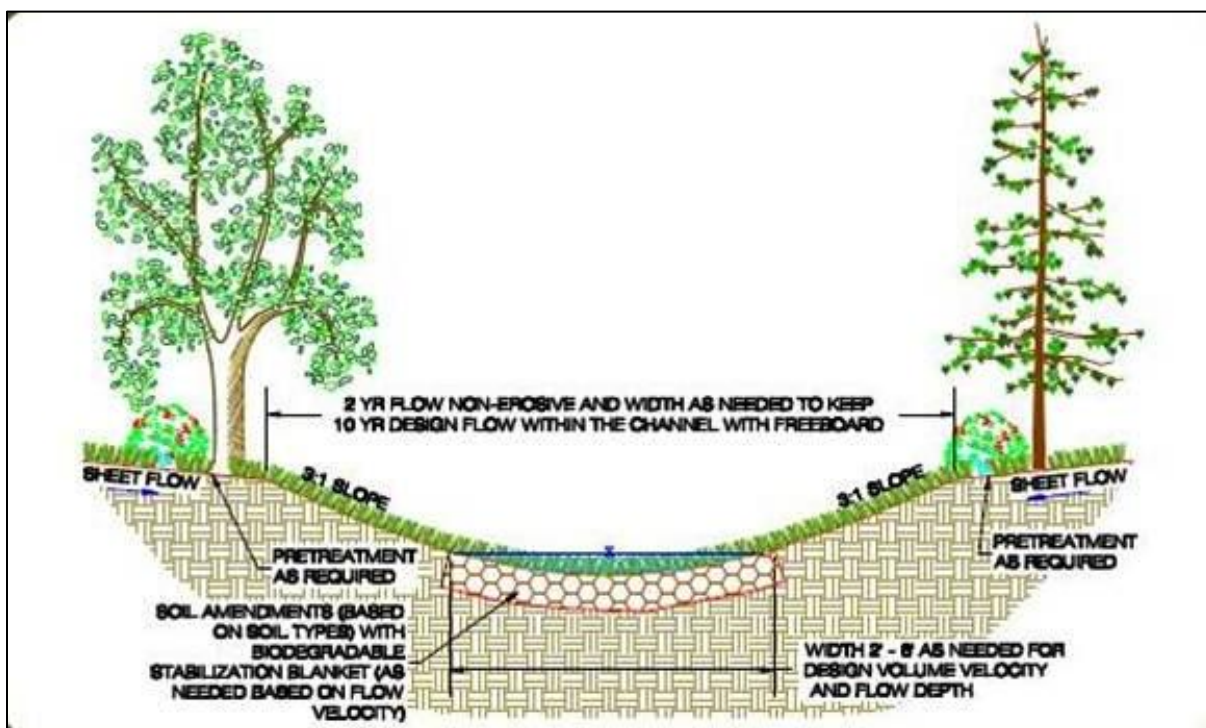





Figure B-1. Schematic of a Grass Channel (WVDEP, 2012)









Figure B-2. Photo of a Grass Channel in Good Condition

Table B-1 outlines the key visual indicators to assess the maintenance condition of grass channels and bioswales, and Table B-2 indicates which indicators are utilized during each of the four different kinds of inspection. Lastly, Table B-3 defines the numeric triggers to classify the maintenance condition of the practice (e.g., pass, minor, moderate or severe problems).

Table B-1
Visual Indicators for Grass Channels and Bioswales^{2,3}

#	INDICATOR	Description & Rationale	Picture
1	CDA Condition	Has the area or land cover in the CDA materially changed from original design assumptions?	 <p><i>Check that the drainage area has not changed.</i></p>
2	Surface Dimensions	Has the width and length of the swale remained the same?	 <p><i>Check the size of the facility to see if it has been altered.</i></p>
3	Flow Distribution	Are flows effectively distributed over the width of the swale or is their visual evidence of gully or channel formation?	 <p><i>Uneven or concentrated flow causes erosion.</i></p>



<p>4</p>	<p>Sediment Deposition</p>	<p>Is there evidence of deposition or caking on the swale bed?</p>	 <p><i>Severe caking on the channel bed.</i></p>
<p>5</p>	<p>Standing Water or Saturated Soils</p>	<p>Any evidence of standing water, ponding, and/or saturation of surface soils w/in the swale 24 hours after storm?</p>	 <p><i>Standing water in grass channel</i></p>
<p>6</p>	<p>Trash/Dumping</p>	<p>Any evidence of excessive trash/dumping that affects aesthetics or interferes with basic mowing operation?</p>	 <p><i>Styrofoam pieces in facility.</i></p>

<p>7</p>	<p>Inlet Obstruction¹</p>	<p>Any evidence that runoff cannot enter the top or lateral sides of the swale due to sediment/turf build up?</p>	
<p>8</p>	<p>Inlet Erosion</p>	<p>Any erosion occurring at storm drain pipe or inflow to head of swale?</p>	
<p>9</p>	<p>Swale Erosion</p>	<p>Any evidence of concentrated overland flow, and/or rill or gully erosion within the swale?</p>	

Sediment accumulation at curb cut inflow.

Erosion at pavement edge where stormwater enters facility.



Severe erosion in the bed of the channel.

<p>10</p>	<p>Side Slope Erosion</p>	<p>Do swale side slopes show evidence of gully or rill erosion?</p>	
<p>11</p>	<p>Vegetative Cover</p>	<p>Does the swale meet numerical targets for turf cover density?</p>	
<p>12</p>	<p>Vegetative Condition</p>	<p>Is the facility's vegetation in good condition, and is free of weeds?</p>	

Erosion of side slope.

Bare area in bottom of facility.

Grass in poor condition.

<p>13</p>	<p>Check Dams (if applicable)</p>	<p>Are structures intact and providing intended design function? (i.e., no evidence of sediment buildup, hydraulic jump, down-gradient erosion or outflanking).</p>	 <p><i>Sediment build-up behind check dams.</i></p>
<p>14</p>	<p>Outflow Obstruction</p>	<p>If swale discharges to a storm drain or catch basin, is there evidence of clogging, sediment deposition or erosion?</p>	 <p><i>Inlet in a grass swale covered by debris.</i></p>
<p>15</p>	<p>Pavement Edge Integrity</p>	<p>Any evidence that the pavement edge is deteriorating or that utilities or other infrastructure are at risk?</p>	 <p><i>Erosion at pavement edge.</i></p>
<p>¹ Both pipe inflow and lateral inflow from road ² Does not include wet swales ³ Dry swales are inspected using the bioretention VI protocol</p>			

**Table B-2
Which Visual Indicators Are Used in Each Swale Inspection¹**

#	INDICATOR	Accept	Maintain	Verify	FBI
1	CDA Condition	X		X	X
2	Surface Dimensions	X		X	X
3	Flow Distribution	X	X	X	X
4	Sediment Deposition	X	X		X
5	Standing Water/ Saturated Soil	X	X	X	X
6	Trash/Illegal Dumping		X		
7	Inlet Obstruction	X	X	X	X
8	Inlet Erosion	X	X	X	X
9	Swale Erosion	X	X	X	X
10	Side Slope Erosion	X	X		
11	Vegetative Cover	X	X		X
12	Vegetative Condition	X	X	X	X
13	Check Dams	X	X		X
14	Outflow Obstruction	X	X		X
15	Pavement Edge Integrity		X		X

¹ Swales should be installed per construction sequence, and confirmed using the appropriate state and/or CWP construction inspection checklist which can be accessed at www.chesapeakestormwater.net.
Some limited survey work may need to be done to confirm swale dimensions and acceptable longitudinal and side slopes.

Table B-3: Defining Numeric Triggers to Classify Swale Maintenance Condition					
#	INDICATOR	PASS	MINOR	MODERATE	SEVERE
1	CDA Condition	No increase in CDA or change in surface cover	Within 5% of design assumption	Departs by as much as 15% from design assumption	Departs by more than 15% from design assumption
2	Surface Dimensions	Width and length meet design	Within 5% of design assumption	Departs by up to 15% from design assumption	Departs by more than 15% from design assumption
3	Flow Distribution	100% of width is utilized	75% of width is utilized	Less than 50% of width is utilized	Less than 25% of width is utilized, evidence of channelization for majority of swale length
4	Sediment Deposition	None	A few isolated caking areas	Deposits up to 3 inches deep	Deposits more than 3 inches deep
5	Standing Water or Saturated Soil	None	Soggy soils 48 hours after rain event	Surface ponding of an inch or less, after 48 hours	Surface ponding of an inch or more after 48 hours for at least 10% of swale surface area
6	Trash	None	Some Litter	Very trashy	Dumping
7	Inlet Obstruction ¹	None, all runoff enters facility	Future risk of bypass	Evidence that some runoff may bypass	Most runoff cannot enter facility
8	Inlet Erosion	None	Some rill erosion	Gully erosion of 6 inches or less	Gully erosion more than 6 inches
9	Swale Erosion	None	Some rill erosion	Gully erosion of 6 inches or less	Gully erosion more than 6 inches
10	Side Slope Erosion	None	Some rill erosion	Gully erosion of 6 inches or less	Gully erosion more than 6 inches
11	Vegetative Cover	>90% turf cover	75-90% turf cover	50-75% turf cover	Less than 50% turf cover
12	Vegetative Maintenance	Well-maintained, few weeds	Isolated areas need re-seeding or weeding	Needs major mowing and weed eradication	Needs major mowing or shrub/tree removal or replanting
13	Check Dams	Good Condition	Minor sediment deposits, out-flanking or down-gradient erosion	Some sediment deposits, out-flanking or down-gradient erosion	Problems are so severe that structure function is compromised
14	Outflow Obstruction	None	Nominal loss of pipe or inlet capacity	Needs to be cleaned out	Clogging. No pipe capacity
15	Pavement Edge	Good condition	Minor deterioration	Edge at risk, longitudinal cracking	Edge is broken and is compromised
<i>Note: based on the numerical trigger, specific maintenance tasks or forensic investigations would be recommended (for minor, moderate and severe problems)</i>					

B.2. Filter Strips and Sheet Flow to Buffer

Sheet Flow to Vegetated Filter Strips and Sheet Flow to Buffers represent the practice of using adjacent vegetated areas to manage stormwater runoff by slowing runoff velocities and allowing sediment and attached pollutants to settle and be filtered by the vegetation.

Vegetated Filter Strips are an engineered practice designed to receive runoff from adjacent land areas. Buffers are areas of conserved open space, conserved or restored riparian buffers. Figure B-3 is an overhead schematic of how runoff is treated by a filter strip or buffer. Figure B-4 is a photo of a filter strip in good condition.

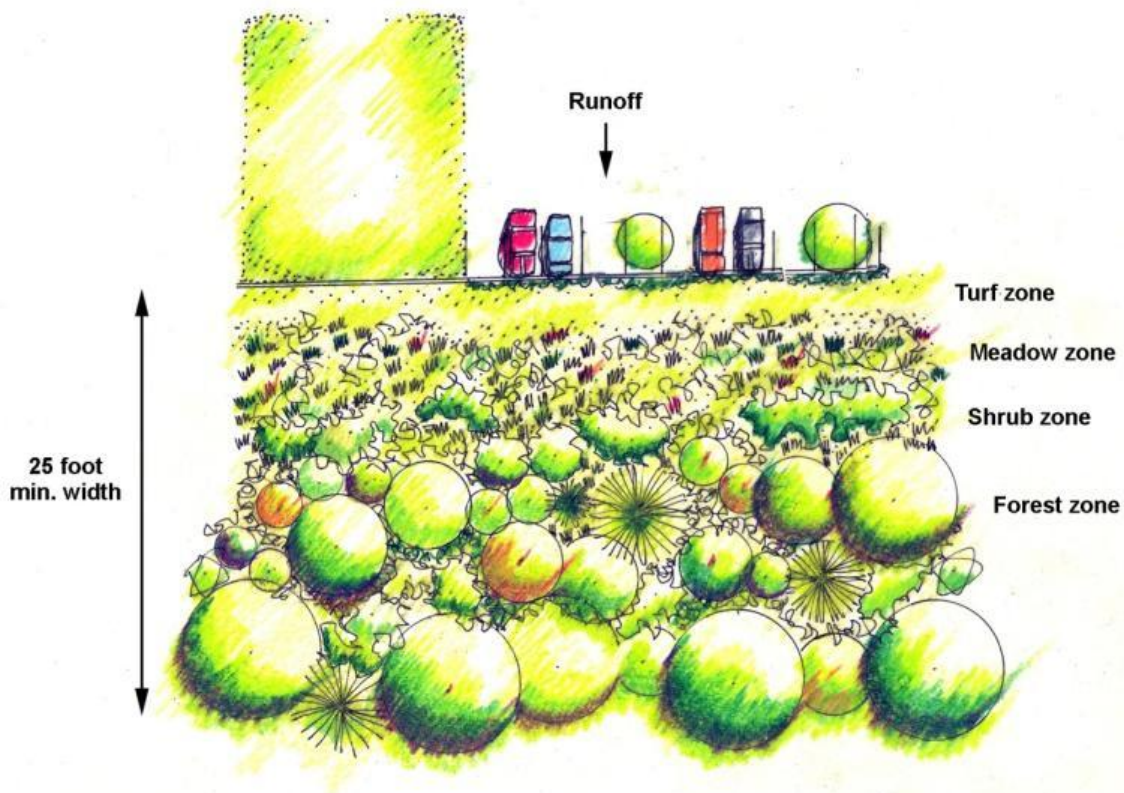







Figure B-3. Schematic of a Filter Strip









Figure B-4. Picture of a Filter Strip in Good Condition

Table B-4 outlines the key visual indicators to assess the maintenance condition of filter strips and sheet flow to buffers, and Table B-5 indicates which indicators are utilized during each of the four different kinds of inspection. Lastly, Table B-6 defines the numeric triggers to classify the maintenance condition of the practice (e.g., pass, minor, moderate or severe problems).

Table B-4			
List of Visual Indicators for Filter Strips/Sheet Flow to Buffer			
#	INDICATOR	Description & Rationale	Picture
1	CDA Condition	Has the area or land cover in the CDA materially changed from original design assumptions?	 <p><i>A change in drainage area means a change in the volume of water entering a facility.</i></p>
2	Surface Dimensions	Has the width and length of the filter remained the same?	 <p><i>Measure the length and width of the facility.</i></p>
3	Flow Distribution	Are flows effectively distributed over the filter width, or is there visual evidence of channel formation?	 <p><i>Concentrated flows can cause erosion.</i></p>

<p>4</p>	<p>Sediment Deposition</p>	<p>Is there evidence of deposition or caking within the filter?</p>	 <p><i>Sediment deposition in a facility.</i></p>
<p>5</p>	<p>Saturated Soils</p>	<p>Any evidence of saturation of surface soil days after a storm?</p>	 <p><i>Saturated soil days after a storm indicates poor drainage.</i></p>
<p>6</p>	<p>Trash/Dumping</p>	<p>Any evidence of excessive trash/dumping that affects aesthetics or interferes with basic mowing operations?</p>	 <p><i>Litter in a facility.</i></p>

<p>7</p>	<p>Inlet Obstruction</p>	<p>Any evidence that runoff cannot enter the filter strip or level spreader due to sediment/turf buildup?</p>	
<p>8</p>	<p>Inlet Erosion</p>	<p>Any evidence of outflanking or erosion below the level spreader?</p>	
<p>9</p>	<p>Filter Strip Erosion</p>	<p>Any evidence of concentrated overland flow, and/or rill or gully erosion along the filter strip gradient?</p>	

<p>10</p>	<p>Vegetative Cover</p>	<p>Does the filter meet its numerical targets for turf or riparian cover?</p>	 <p><i>Erosion can occur wherever there is a lack of vegetative cover.</i></p>
<p>11</p>	<p>Vegetative Condition</p>	<p>Is the filter in good grass or meadow condition and weed- free?</p>	 <p><i>Vegetation in poor condition.</i></p>
<p>12</p>	<p>Level Spreaders</p>	<p>Is the structure intact and providing its intended design function? (i.e., no evidence of sediment buildup, hydraulic jump or out-flanking)</p>	 <p><i>Accumulation of sediment along a level spreader. Vegetation is growing in the sediment at the edge of the pavement.</i></p>



13	Outflow Condition	Does the grass filter effectively transition to a stream buffer or forest?	 <p><i>Stormwater first flows through the grass filter strip, and then a strip of forest before reaching the stream.</i></p>
14	Pavement Edge Integrity	Any evidence that the pavement edge is deteriorating or that utilities or other infrastructure are at risk?	 <p><i>Erosion at pavement edge.</i></p>

Table B-5					
Which Visual Indicators Are Used in Each Filter Strip Inspection					
#	INDICATOR	Accept	Maintain	Verify	FBI
1	CDA Condition	X		X	X
2	Surface Dimensions	X		X	X
3	Flow Distribution	X	X	X	X
4	Sediment Deposition	X	X		X
5	Saturated Soils	X	X	X	X
6	Trash/Illegal Dumping		X		
7	Inlet Obstruction ¹	X	X	X	X
8	Inlet Erosion	X	X	X	X
9	Filter Erosion	X	X	X	X
10	Vegetative Cover	X	X		X
11	Vegetative Condition	X	X	X	X
12	Spreaders	X	X	X	X
13	Outflow Condition	X	X		X
14	Pavement Edge Integrity	X			X
¹ Filter strips should be installed per construction sequence, and confirmed using the CWP construction inspection checklist which can be accessed at www.chesapeakestormwater.net . Some limited survey work may need to be done to confirm filter strip dimensions and longitudinal slopes.					

**Table B-6:
Defining Numeric Triggers to Classify Filter Strip Maintenance Condition**

#	INDICATOR	PASS	MINOR	MODERATE	SEVERE
1	CDA Condition	No increase in CDA or change in surface cover	Within 5% of design assumption	Departs up to 15% from design assumption	Departs more than 15% from design assumption
2	Surface Dimensions	Width and length meet design	Within 5% of design assumption	Departs up to 15% from design assumption	Departs more than 15% from design assumption
3	Flow Distribution	100% of filter width is utilized	75% of filter width is utilized	Less than 50% of filter width is utilized	Less than 25% of filter width utilized and evidence of short-circuiting
4	Sediment Deposition	None	A few isolated caking areas	Deposits up to 3 inches deep	Deposits more than 3 inches deep
5	Saturated Soil	Soils are dry 48 hours after storm	Soggy soils 12 hours after rain event	Soggy soils 24 hours after rain event	Soggy soils 48 hours after rain event
6	Trash	None	Some Litter	Very trashy	Dumping
7	Inlet Obstruction	None, all runoff enters filter	Future risk of bypass	Evidence that some runoff may bypass	Most runoff cannot enter filter
8	Inlet Erosion	None	Some rill erosion	Gully erosion of 6 inches or less	Gully erosion of more than 6 inches
9	Filter Erosion	None	Some rill erosion	Gully erosion of 6 inches or less	Gully erosion of more than 6 inches
10	Vegetative Cover	Dense turf cover (90%)	Isolated bare spots	Turf cover of 75% or more	Turf cover less than 75%
11	Vegetative Maintenance	Well-maintained	Isolated areas need re-seeding or weeding	Needs major mowing and weed eradication	Needs major moving, shrub/tree removal and/or re-planting
12	Level Spreaders	Good Condition	Minor sediment deposits or down-gradient erosion	Some undercutting or deposits above and/or down-gradient erosion	Problems are so severe that structure function is compromised
13	Outflow Condition	Good, remains as sheet flow	Some isolated flow channelization	Risk of short-circuiting and erosion	Evidence of short-circuiting and erosion
14	Pavement Edge Integrity	Good edge condition	Minor deterioration	Risk of significant deterioration	Pavement or curb stops are compromised

Note: based on the numerical trigger, specific maintenance tasks or forensic investigations would be recommended (for minor, moderate and severe problems)

B.3. Permeable Pavement

Permeable pavements are alternative paving surfaces that allow stormwater runoff to filter through voids in the pavement surface into an underlying stone reservoir, where it is temporarily stored and/or infiltrated. Figure B-5 is a schematic of permeable pavement; Figure B-6 is a photo of permeable pavement in good condition.

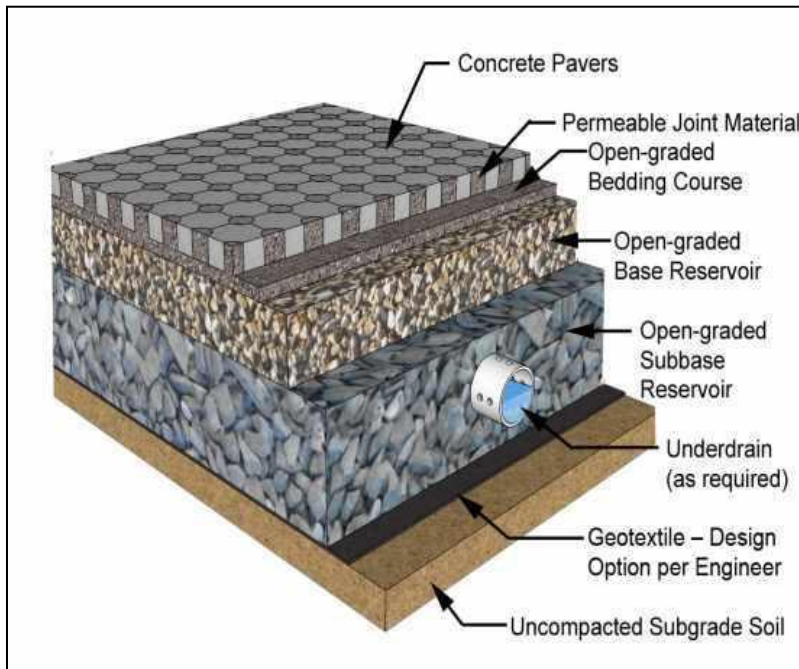







Figure B-5. Schematic Profile for Typical Permeable Pavement Section (Source: David Smith, ICPI).









Figure B-6. Photo of Permeable Pavement in Good Condition

Table B-7 presents the 12 visual indicators that are used to assess the maintenance condition of permeable pavement, and Table B-8 indicates which ones are utilized during each of the four different kinds of inspection. Table B-9 defines the numeric triggers to classify the maintenance condition of permeable pavement (pass, minor, moderate or severe problems).

Table B-7			
Permeable Pavement Visual Indicators¹			
#	INDICATOR	Description and Rationale	Picture
1	CDA Run-on	For facilities with a CDA: stable, no exposed soils, no increase in CDA, no mulch or grass clippings discharging to pavement. Upgradient asphalt CDA should be free and clear of grit and fines.	 <p><i>Contributing drainage area should be clear of materials that might clog porous/permeable pavement.</i></p>
2	Pavement Surface Area	Surface area of permeable pavement matches design, and has not been sealed or re-paved with non-permeable materials	 <p><i>Compare the size of the facility with the plans.</i></p>

<p>3</p>	<p>Pavement Sinking</p>	<p>Surface should match design slope, with no low points or depressions that promote concentrated inflow or indicate stone reservoir is settling</p>	 <p><i>Sunken area in permeable pavement parking lot.</i></p>
<p>4</p>	<p>Surface Clogging</p>	<p>Evidence of sediment or vegetative accumulation on pavement surface or within pavement voids</p>	 <p><i>Sediment clogging permeable pavement.</i></p>
<p>5</p>	<p>Standing Water</p>	<p>Evidence that stormwater is not getting thru the pavement in all or part of the facility</p>	 <p><i>There should be no standing water on permeable pavement after a rain event.</i></p>

<p>6</p>	<p>Pavement Staining</p>	<p>Evidence of hydrocarbons or other pavement staining that could impair performance</p>	 <p><i>Oil stains on permeable pavement.</i></p>
<p>7</p>	<p>Surface Deterioration</p>	<p>Evidence of spalling, cracking or breakup of pavement or paver blocks, in all or part of the facility</p>	 <p><i>Loose gravel on permeable pavement.</i></p>
<p>8</p>	<p>Flow Test</p>	<p>Rapid test to determine whether pavement flow thru is compromised in “at risk” sections of facility</p>	 <p><i>A flow test checks for clogging on the surface.</i></p>

<p>9</p>	<p>Overflow Obstruction</p>	<p>Evidence that runoff from larger storms safely conveys from the facility</p>	 <p><i>Flooding due to obstruction of overflow.</i></p>
<p>10</p>	<p>Underdrain or Observation Well</p>	<p>Evidence of sediment or blockage or poor stormwater clearance after a storm</p>	 <p><i>Underdrain cleanouts and observation wells should be clear of water after a rain event.</i></p>
<p>11</p>	<p>Structural Integrity</p>	<p>Evidence of water-based damage to pavement edge, curbs, sidewalks or infrastructure</p>	 <p><i>Erosion at pavement edge.</i></p>

12	Parking Lot Management Practices	Good practices on parking lot and adjacent CDA (no over-size vehicles, no outdoor material storage, leaky dumpsters, proper winter maintenance (no sand or salt), healthy landscaping, leaking dumpsters, etc)	
¹ Applies to pervious concrete, porous asphalt and interlocking pavers			

**Table B-8
Which Visual Indicators are Used in Permeable Pavement
Assessment¹**

#	INDICATOR	Accept	Maintain	Verify	FBI
1	CDA Run-on	X	X	X	X
2	Pavement Area	X		X	
3	Pavement Sinking	X	X		X
4	Surface or Void Clogging	X	X	X	X
5	Standing Water	X	X	X	X
6	Pavement Staining		X	X	X
7	Surface Deterioration	X	X		X
8	Flow Test	X		X	X
9	Overflow Condition	X	X		
10	Underdrain/Observation Wells	X	X	X	X
11	Structural Integrity	X	X		X
12	Parking Mgmt. Practices	X		X	

¹ Permeable pavement should be installed per approved construction sequence, and confirmed using the CWP construction inspection checklist which can be accessed at www.chesapeakestormwater.net.



A simple flow through test should be conducted in at-risk pavement sections

Table B-9 Defining Numeric Triggers to Classify Permeable Pavement Maintenance Condition					
#	INDICATOR	PASS	MINOR	MODERATE	SEVERE
1	CDA Run-on	No CDA, or CDA in good condition	CDA, has some isolated spots that generate sediment, grit or fines	CDA in fair to poor condition, and appears to have a risk for sediment, grass clipping or mulch delivery or grit/fines from upgradient non-permeable pavement	Exposed soils, erosion or stored materials in CDA are clearly delivering sediment to pavement
2	Pavement Areas	Matches design	Within 5% of design area	Departs by up to 10% of design area	Departs by more than 10% of design area
3	Pavement Sinking	Surface is flat	A few depressions, less than an inch deep	Localized depressions are up to three inches deep	Widespread sinking or localized depressions more than 6 inches deep
4	Surface or Void clogging	Surface is clean and voids are particle free	Enough particles are present to warrant increased vacuuming	Significant sediment accumulation on surface and or in pavement void spaces	Sediment particles prevent flow through pavement, or vegetative growth observed
5	Standing Water	None	Isolated surface moisture	Ponding on up to 10% of surface	Ponding on more than 10% of surface
6	Surface Staining	No Staining	Isolated water stains	Stains on up to 10% of surface	Stains on more than 10% of surface
7	Surface Deterioration	Good Condition	Deterioration of less than 5% of surface, cracks less than half inch	Problems found on less than 10% of surface, cracks deeper than 1/2 in	Problems found on more than 10% of surface. Major cracking/separation
8	Flow Test	Not needed	Flow-thru occurs within test period	Testing of all high risk areas (VI 2 to 7)	Flow-thru does not occur within test period
9	Overflow Condition	Good	Minor problems	Partially obstructed	Totally obstructed
10	Underdrain/ Observation Well	Clean	Minor deposits, no dry weather flow	Dry weather flow and/or sediment/gravel accumulation	Evidence that stone reservoir is not draining or is obstructed
11	Structural Integrity	Good	Some water entry where it is not desired	Early signs of failure	Failure
12	Parking Management Practice	No Risk	Minor Risk for Clogging	Strong Risk of Clogging	Practices causing failure
<p><i>Note:</i> based on the numerical trigger, specific maintenance tasks or forensic investigations would be recommended (for minor, moderate and severe problems).</p>					

B.4. Subsurface Infiltration Practices

Infiltration practices capture and temporarily store runoff before allowing it to infiltrate into the underlying soil over a period of approximately two days. Figure B-7 is a schematic of an infiltration practice; Figure B-8 is a picture of an infiltration basin in good condition.

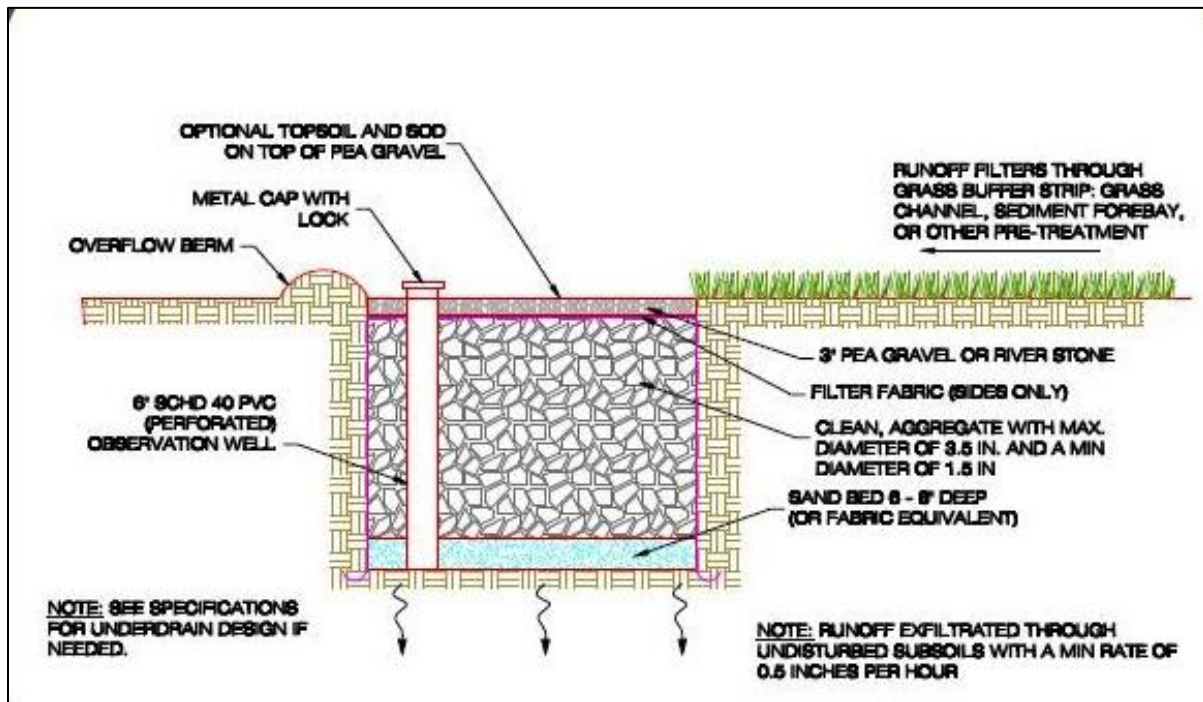



Figure B-7. Schematic of Infiltration Practice









Figure B-8. Photo of Infiltration in Good Condition



The following visual indicators apply to most sub-surface infiltration trenches and dry wells, but they should not be used to assess larger infiltration basins with surface ponding.

Table B-10 presents the 12 visual indicators that are used to assess the maintenance condition of infiltration practices, and Table B-11 indicates which ones are utilized during each of the four different kinds of inspection. Table B-12 defines the numeric triggers to classify the maintenance condition of infiltration practices (e.g., pass, minor, moderate or severe problems).

Table B-10 Visual Indicators for Infiltration Practices			
#	INDICATOR	Description and Rationale	Picture
1	Surface Area	Surface dimensions agree with design	 <p><i>Check the dimensions of the facility.</i></p>
2	CDA Condition	Stable, no exposed soils, no increase in CDA from design assumptions	 <p><i>The contributing drainage area should be clear of sediment and debris that will compromise the facility.</i></p>

<p>3</p>	<p>Surface Sinking</p>	<p>Surface is not flat, or has low points or depressions, particularly near perimeter edges</p>	 <p><i>Sinkhole in a facility.</i></p>
<p>4</p>	<p>Sedimentation or Plant Growth</p>	<p>Sediment or plant growth observed on the surface of the infiltration bed</p>	 <p><i>Test pit showing sediment accumulation in gravel layer.</i></p>
<p>5</p>	<p>Standing Water</p>	<p>Standing water on surface within 6 hours after a storm</p>	 <p><i>Standing water should infiltrate into a facility immediately.</i></p>

<p>6</p>	<p>Surface Staining</p>	<p>Evidence of hydrocarbon or other staining on surface</p>	 <p><i>Stain on surface of a facility.</i></p>
<p>7</p>	<p>Poor Observation Well Measurement</p>	<p>Standing water observed in observation well (OW) after 72 hours of a storm</p>	 <p><i>Water inside an observation well might indicate poor drainage from a facility.</i></p>
<p>8</p>	<p>Observation Well & Cap</p>	<p>Well and cap are not intact, cannot be opened or allow for measurement of water clearance rate</p>	 <p><i>Damaged observation well.</i></p>

<p>9</p>	<p>Pretreatment Condition</p>	<p>Pretreatment not in working condition and has insufficient capacity to trap sediment/debris</p>	 <p><i>Strong flows are dispersing the stone and eroding the pretreatment.</i></p>
<p>10</p>	<p>Inlet Conditions</p>	<p>Runoff cannot enter the bed and/or erosion observed at the inlet boundary</p>	 <p><i>Erosion at a curb cut inflow.</i></p>
<p>11</p>	<p>Underdrain</p>	<p>Evidence of stone or sediment, blockage or dry weather flows well after a storm</p>	 <p><i>Sediment inside underdrain.</i></p>

12	Overflow Condition	The outlet or overflow does not have full capacity to convey flow events that exceed the water quality storm design event	 <p data-bbox="841 611 1182 642"><i>A clogged outflow structure.</i></p>
-----------	--------------------	---	--

Table B-11 Which Visual Indicators Are Used for Each Infiltration Assessment					
#	INDICATOR	Accept	Maintain	Verify	FBI
1	Surface Area	X		X	X
2	CDA Condition	X	X		X
3	Surface Sinking	X	X	X	X
4	Sedimentation or Plant Growth	X	X	X	X
5	Standing Water	X	X	X	X
6	Surface Staining	X		X	X
7	Observation Well Measurement	X	X	X	X
8	Observation Well and Cap	X	X		
9	Pretreatment Condition	X	X	X	X
10	Inlet Condition	X	X		X
11	Underdrain	X	X		X
12	Overflow Condition	X	X		

¹ Subsurface infiltration should be installed per approved construction sequence, and confirmed using the CWP inspection checklist to deal with below and above ground construction elements of infiltration construction, which can be accessed at www.chesapeakestormwater.net.



A quick check of the depth of water in the observation well should be done in every inspection

**Table B-12
Maintenance Triggers for Infiltration Practices**

#	INDICATOR	PASS	MINOR	MODERATE	SEVERE
1	Surface Area	Matches design	Within 5% of design area	Departs by up to 10% of design area	Departs by more than 10% of design area
2	CDA Condition	CDA in good condition	CDA has some isolated spots that generate sediment	CDA in fair to poor condition, and has a risk for sediment, grass clipping or much delivery	Exposed soils or erosion in CDA is clearly delivering sediment to practice
3	Surface Sinking	Flat and at grade	A few depressions, less than 3 inches deep	Sinking of up to 6 inches from grade	Widespread sinking more than 6 inches deep
4	Sediment/ Plant Growth	No deposits or plant growth	Minor deposits of particles on surface	Sediment and organics found to a depth of 6 inches in practice	Sediment particles prevent flow into or distribution across practice and vegetative growth observed
5	Standing Water	None	Some moisture in first foot	Ponding on up to 10% of surface 6 hours after storm	Ponding on up to 10% of surface 12 hours after storm
6	Surface Staining	None	Isolated minor stains	Stains on up to 10% surface	Stains on more than 10% of surface
7	Observation Well (OW) Measurement	No water present in OW	Less than 3 inches of water in well 72 hours after storm	Up to a foot of water in OW 72 hours after storm	More than a foot of water in well 72 hours after a storm
8	Observation Well & Cap	Intact, clean and dry	Minor deposits of sediment or gravel (< 3 in)	3 to 6 inches of sediment or gravel in the well	OW is broken, missing, obstructed or not accessible
9	Pretreatment Condition	Good	Minor sediment accumulation to remove.	More than 50% of pretreatment capacity lost, need cleanout or renovation	Pretreatment is missing, or no longer functioning to trap sediment
10	Inlet Obstruction	None, all runoff enters filter	Future risk of bypass	Evidence that some portion of runoff is bypassing practice	Most runoff cannot enter the infiltration practice
11	Underdrain	Good	Minor deposits, no dry weather flow	Dry weather flow and/or sediment/gravel accumulation	Evidence that stone reservoir is not draining or is obstructed
12	Overflow Condition	Good	Minor problems	Partially obstructed	Totally obstructed